

Congratulations on purchasing the best network controlled power switch available. This manual covers two models, iBoot-G2+ and iBoot-G2S. This manual refers to the iBoot-G2+ and notes the changes for the iBoot-G2S.

- **Web Setup and Control:** Simple browser interface for one click reboot and all configuration.
- **iBoot Cloud Service:** Control all your iBoots from a single sign-on. Eliminates port-forwarding and security issues.
- **Telnet:** setup and control of all functions. Allows easy scripting.
- **Network Switch:** Built-in 2 Port 10/100 Network Switch (iBoot-G2S only). Eliminates need for extra router port and simplifies installation.
- **Expansion:** Add low cost iBoot-EXP units for up to three outlets controlled.
- **I/O Control:** Control or Monitor your own digital Inputs and Outputs. Use inputs to control the local AC outlet.
- **AutoPing:** Automatic monitoring and action for failed equipment.
- **Graceful Shutdown:** attempt a soft shutdown or reboot before controlling power.
- **Disable Off:** To prevent accidental off state of an outlet.
- **Event Scheduling:** Power actions on regular intervals. (14 events)
- **Management Utility:** Easy Setup, Firmware upgrades and Reset to Factory Default
- **Easy Software Integration:** Use the DxP Protocol to build your own custom applications.
- **Control Software:** Create batch files or Shortcuts to control power.
- **URL control:** Create your own website link to control power.
- **API control:** Control and setup Utilizing the cloud registration
*API protocol is detailed in a separate document



iBoot-G2+



iBoot-G2S

1. Table of Contents

1. Table of Contents.....	1	8. iBoot Cloud Service	27
2. Important Safety Instructions	2	9. Command Line Interface.....	29
3. General Description	3	10. DxP Protocol	38
4. Hardware Installation	5	11. Firmware Upgrades.....	38
5. Initial Configuration	9	12. Troubleshooting	39
6. Web Browser Operation.....	11	13. Specifications	40
7. Web Setup	15	14. Technical Support and Warranty	41

2. Important Safety Instructions

When using this product, basic safety precautions should always be followed to reduce the risk of fire, electric shock, and injury to persons, including the following:

1. Read and understand all instructions.
2. Follow all warnings and marked on the product.
3. Unplug this product from the wall outlet before cleaning. Do not use liquid cleaners or aerosol cleaners. Use a damp cloth for cleaning.
4. Do not use this product in an outdoor environment or near water, for example, near a bath tub, wash bowl, kitchen sink, or laundry tub, in a wet basement, or near a swimming pool.
5. Do not place this product on an unstable cart, stand, or table. The product may fall, causing serious damage to the product.
6. Slots and openings in this product and the back or bottom are provided for ventilation to protect it from overheating; these openings must not be blocked or covered. The openings should never be blocked by placing the product on the bed, sofa, rug, or other similar surface. This product should never be placed near or over a radiator or heat register. This product should not be placed in a built-in installation unless proper ventilation is provided.
7. This product should be operated only from the type of power source indicated on the marking label. If you are not sure of the type of power supply to your home, consult your dealer or local power company.
8. This product is equipped with a three wire grounding type plug, a plug having a third (grounding) pin. This plug will only fit into a grounding type power outlet. This is a safety feature. If you are unable to insert the plug into the outlet, contact your electrician to replace your obsolete outlet. Do not defeat the safety purpose of the grounding type plug. Do not use a 3-to-2 prong adapter at the receptacle; use of this type adapter may result in risk of electrical shock and/or damage to this product.
9. Do not allow anything to rest on the power cord. Do not locate this product where the cord will be abused by persons walking on it.
10. Do not overload wall outlets and extension cords as this can result in the risk of fire or electric shock.
11. Never push objects of any kind into this product through slots as they may touch dangerous voltage points or short out parts that could result in a risk of fire or electrical shock. Never spill liquid of any kind on the product.
12. To reduce the risk of electrical shock, do not disassemble this product, but take it to a qualified serviceman when some service or repair work is required. Opening or removing covers may expose you to dangerous voltages or other risks. Incorrect re-assembly can cause electric shock when the appliance is subsequently used.
13. Unplug this product from the wall outlet and refer servicing to qualified service personnel under the following conditions:
 - a) When the power supply cord or plug is damaged or frayed.
 - b) If liquid has been spilled into the product.
 - c) If the product has been exposed to rain or water.
 - d) If the product does not operate normally by following the operating instructions. Adjust only those controls that are covered by the operating instructions because improper adjustment of other controls may result in damage and will often require extensive work by a qualified technician to restore the product to normal operation.
 - e) If the product has been dropped or has been damaged.
 - f) If the product exhibits a distinct change in performance.
14. Avoid using a telephone (other than a cordless type) during an electrical storm. There may be a remote risk of electric shock from lightning.
15. Do not use the telephone to report a gas leak in the vicinity of the leak.
16. Do not exceed the maximum output rating of the auxiliary power receptacle.

Save These Instructions

3. General Description

The iBoot-G2+ is a network attached, IP addressed, web controlled AC power switch. Anyone with a web browser can access iBoot-G2+ to perform power On, Off or Power Cycle (Reboot or Power Burst). iBoot-G2+ access is password protected with user and administrator security levels.

iBoot-G2+ features international standard IEC320 connections and is compatible with power mains worldwide. A simple Web browser interface makes it easy to control power from anywhere in the world with a click of a mouse. iBoot-G2+ also supports Telnet for text commands as well as Dataprobe's Exchange Protocol (DxP) for interfacing to a variety of Dataprobe products and custom software development.

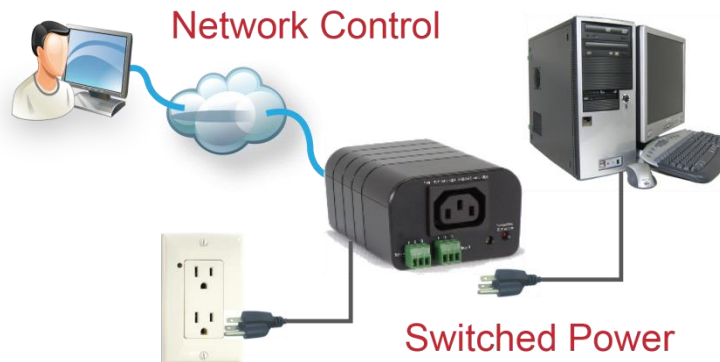

3.1. Uses for iBoot

- Remote reboot of any device, routers, servers, kiosks, etc. The device to be rebooted does not need to be network attached.
- Secure sensitive devices by keeping them powered off when not in use. This prevents hackers from seeing them at all times.
- Power down equipment when not needed for power savings and to save on wear and tear.
- Power up alert devices like sirens, lamps, messages; or control environmental system like heaters, coolers pumps, etc.

3.2. Multiple Control Options

In addition to the Web control capabilities, iBoot-G2+ features several other means to operate automatically or under computer control.

URL Control: You can send a single URL to the iBoot-G2+ containing all the information necessary to query or change the power status. This makes it easy to create a single button on your desktop or embed into a batch file or script.

AutoPing and Heartbeat: The AutoPing feature allows iBoot-G2+ to automatically detect failed equipment and perform a timed reboot or other power control function (like turning on an indicator or siren). You set up to four IP addresses to be periodically pinged. When iBoot-G2+ no longer detects a response from the address(es), the programmed power control function is actuated.

The heartbeat function works in reverse; it looks for a message from a device and takes action when that message is no longer received. The heartbeat generator app installs in your server and allows the iBoot-G2+ to auto reboot when the server crashes.

Telnet: iBoot's Command Line Interface (CLI) allows direct control and setup through Telnet.

USB: iBoot's Command Line Interface (CLI) allows direct control and setup through the USB port.

Dataprobe Exchange Protocol: iBoot-G2+ supports Dataprobe Exchange Protocol (DxP) This protocol allows Dataprobe products to communicate across networks, and allows developers to design custom applications to integrate iBoot-G2+ into custom applications. For more information about DxP, contact Dataprobe Applications Engineering and Support.

API: when iBoot-G2+ is connected to a cloud account, there is an API to send control and configuration data between the cloud and the device. API protocol is detailed in a separate document.

3.3. Expansion to Three Outlets

iBoot-G2+ can be linked to two expansion units, iBoot-Exp to control three outlets. All three outlets are controlled and managed through the iBoot-G2+ web page and CLI. Each outlet is independently controlled. AutoPing and Heartbeat can be used to control the main and expansion units independently as well.



Expand to 3 Outlets with iBoot-Exp

3.4. Expansion to GPIO

When not used for expansion to iBoot-Exp, the Expansion Ports on the iBoot-G2+ can be used as general purpose I/O (GPIO) to monitor and control additional devices. Inputs on the expansion ports can be used to monitor alarm contacts, environmental sensors, relays and switch closures. The outputs can drive relays for process control, security and environmental controls.

The inputs can also be used to control the power of the main power. Several modes of operation allow the inputs to be connected to physical switches or other management systems that generate contact closures to control the power. Inputs 1 and 2 can be set for a variety of power control options, including locking an outlet to On or Off to disable other control methods and secure a device.

iBoot-G2+ uses Dataprobe Exchange Protocol (DxP) to communicate with other Dataprobe devices to allow transport of GPIO information across the network. DxP protocol is available from Dataprobe's website, allowing you to create programs to monitor and control any Dataprobe DxP enabled device, or exchange status and control between devices across the network.

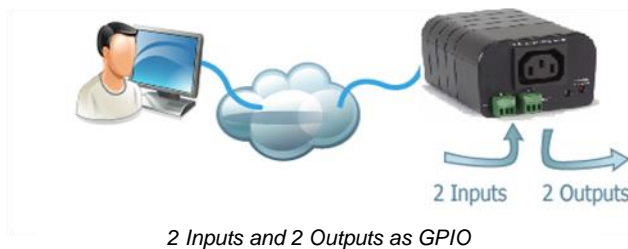

4. Hardware Installation

4.1. Ethernet Connections

iBoot-G2+ supports one 10/100 Ethernet connection using the cable supplied, or other suitable unshielded twisted pair (Cat 5) cabling. Activity (green) and 100Mb (amber) LEDs on the network connector indicate when the network connection is properly established and when the connection is 100 Mbit/s.

iBoot-G2S supports two 10/100 Ethernet connections. The built in two port unmanaged switch allows uplink and downlink connections to be made through the iBoot-G2S to be inserted into an existing cable run without the need for a separate switch.

Either port can be connected to the uplink (network) or downlink (device). Use the cable provided or other suitable unshielded twisted pair (Cat 5) cabling. Activity (green) and 100Mb (amber) LEDs on the network connector indicate when the network connection is properly established and when the connection is 100 Mbit/s.

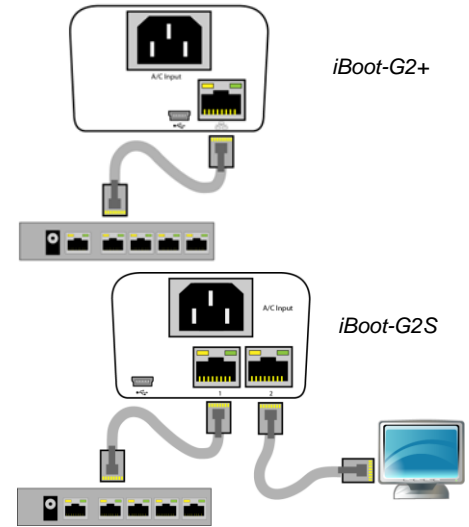

Connect 10/100 Ethernet

4.2. AC Power Connections

Connect the device to be powered ON and OFF to the IEC receptacle marked A/C Output. An IEC 320 to North American (NEMA 5-15) power cord is included for connecting the iBoot-G2+ outlet to the device to be controlled.

If a cord with a different terminating receptacle is required, be sure it is properly rated and meets all the required local electrical standards. If the device to be powered uses an IEC320 receptacle and detachable power cord, an IEC to IEC extension cord can be used.

The iBoot-G2+ can be connected to a power strip to allow simultaneous control of multiple devices. Make sure that the combined load of all controlled devices does not exceed 12 Amps for 105-125VAC or 10 Amps for 210-240VAC.

An LED Indicator next to the Switched Outlet will be On to indicate that the power is On at that outlet. This LED will turn Off to indicate that the power is Off to the outlet.

Connect the supplied power cord to the connector labeled AC Input, and the other end to your AC source. If a power cord with a different terminating plug is required, be sure it is properly rated and meets all the required local electrical standards.

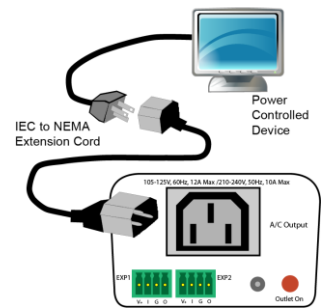

IEC to NEMA 5-15 Outlet Cord for North America Included

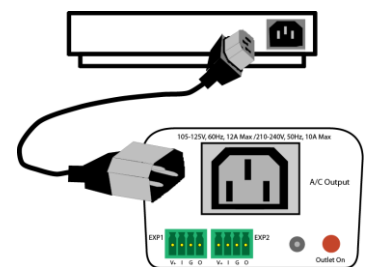

Source Additional Outlet Cables Locally

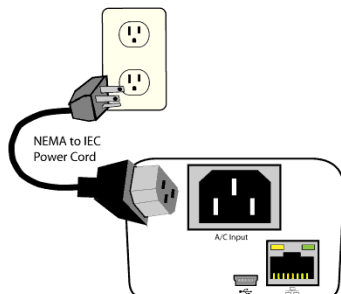

Power Cord for North America Included

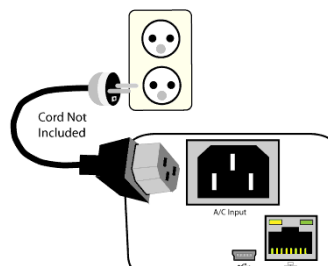

Source Additional Power Cords Locally

4.3. Expansion Connections

iBoot-G2+ has two Expansion Ports, Exp1 and Exp2 for connection to iBoot-Exp, or for use as General Purpose Inputs and Outputs (GPIO). Mode settings on the iBoot-G2+ determine how the expansion ports function.

Connections to the iBoot-Exp are made using screw terminal blocks. The screw terminal blocks are on removable connectors for easy cable fabrication.

Make sure screw terminals are tightened securely and that there are no loose strands of cable, or excessive stripped wires.

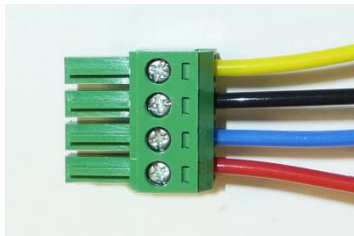

Proper Screw Terminal Connections

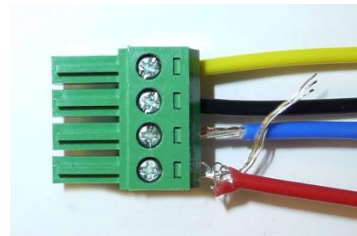

Poor Screw Terminal Connections. Note Loose Wires and Excessive Stripping

Connecting to iBoot-Exp

Terminal blocks are connected pin-to-pin with the iBoot-Exp as shown:

Connect:

Function	iBoot-G2+	iBoot-Exp
Power	V+ Power Out	V+ Power In
Feedback	I Input	O Output
Ground	G Ground	G Ground
Command	O Output	I Input

Expansion units (iBoot-Exp) are shipped with a cable for easy connection to the iBoot-G2+ . Maximum cable length is 1000 ft (305 m) using 22 AWG wire.

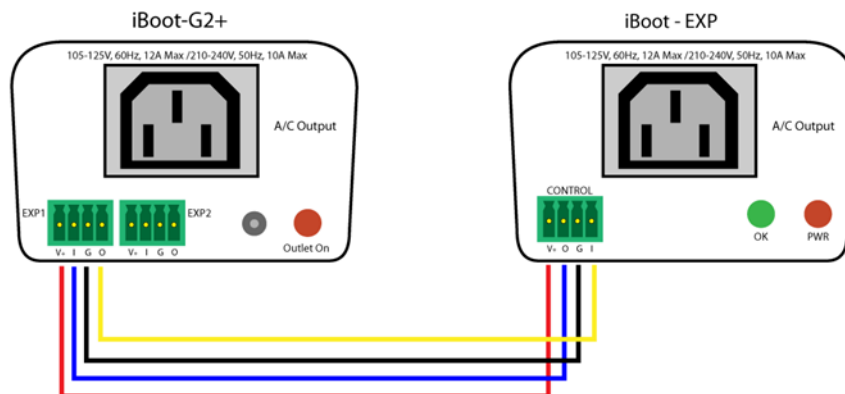

iBoot-G2+ to iBoot-EXP Connections

Connection for physical switch for power control

Connection to the I/O connector for power control uses pins 2 and 3 as shown in the connection diagram. The function of the switch is determined by the setup. see Expansion Settings [section 7.2](#)

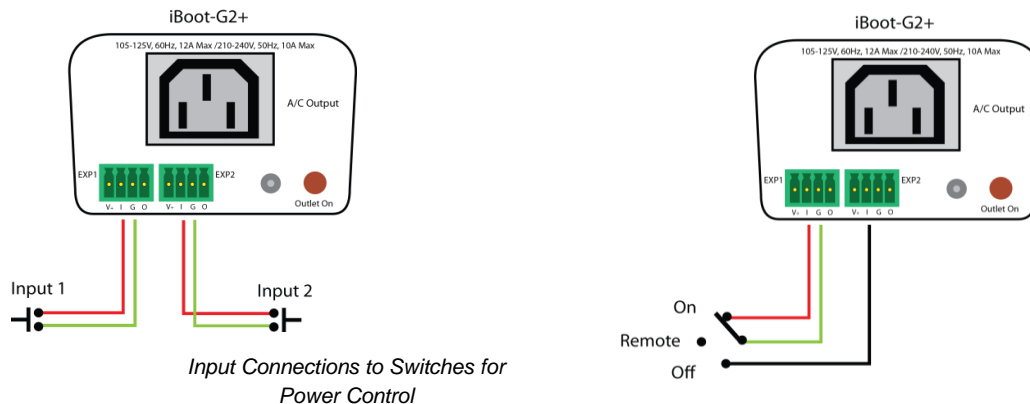

Connection to General Purpose I/O

Function	iBoot-G2+	Description
Power	V+ Power Out	This is +12 VDC power out from the iBoot-G2+ Maximum current 100 mA
Feedback	I Input	Input for status signals. Dry Contact input or Open Collector.
Ground	G Ground	Signal Ground for Input and Output
Command	O Output	2N3904 NPN Transistor. 100 mA Maximum

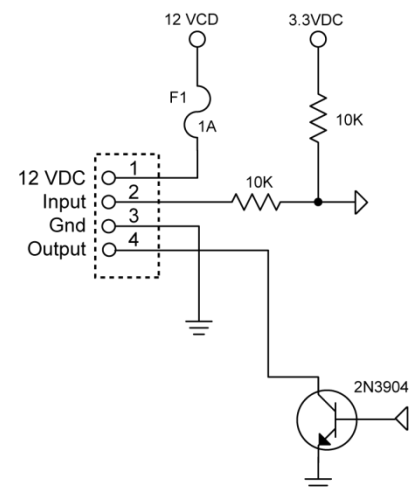

Schematic of Input and Output Connections Used as General Purpose I/O

4.4. USB Connection

The iBoot-G2+ has a USB connection that can be used for:

- Connection to a PC for setup and control
- Connection to a PC for heartbeat monitoring

To use the USB port, connect to a Windows PC, and the installation should be automatic. If you need to install a driver first you can download the driver at <http://dataprobe.com/support-iboot-g2-plus>

USB Driver Installation

- Run iBootG2Driver.exe prior to connecting the iBoot-G2+ to the USB port of the PC.
- Connect the USB iBoot-G2+ to a USB port of the PC.
- The PC will discover the iBoot-G2+ and assign a COM port. To find the COM port go to
- Control Panel > System > Device Manager > Ports (COM & LPT) The com port assigned will be USB Serial Port (COMn)

The USB port can now be used with a standard Terminal Client (like HyperTerminal) to communicate directly with the iBoot-G2+. Dataprobe also provides a simple terminal program (EZ Term) at <http://dataprobe.com/support-iboot-g2-plus>

4.5. Mounting Options

iBoot-G2+ is suitable for desktop or shelf mounting. A mounting kit for wall and DIN rail mounting is available. Order part:

1920033 Mounting Kit for iBoot-G2+ G2 Series



Remove all cables from the unit prior to installing or removing any mounting hardware.



1920033 Mounting Kit
iBoot G2 Series

Installing the Wall Mounting Kit	
<p>1. Remove the four mounting screws from the underside of the unit.</p> <p>Do not disassemble the unit.</p>	
<p>2. Install the wall mounting ears to the unit using the screws removed in Step 1</p>	
<p>3. The unit is ready for wall mounting.</p>	
<p>4. Use M3 or #4 screws for attachment to suitable surface</p>	

DIN Rail Mounting	
<p>1. Install the Wall Mounting Kit as shown. (use steps 1-3 to the left)</p>	
<p>2. Install the DIN rail clips using the four screws provided.</p>	
<p>3. Ready for DIN rail mounting.</p>	

5. Initial Configuration

5.1. Auto Configuration

If your network supports Dynamic Host Configuration Protocol (**DHCP**), the iBoot-G2+ will be automatically assigned an IP Address and be ready to use. You can discover the IP Address through your Server/Router, or use Dataprobe's Device Management Utility (DMU).

5.2. Device Management Utility

The Device Management Utility (DMU), program available online at <http://dataprobe.com/support-iboot-g2-plus>, provides the easiest means to find and configure your iBoot-G2+ for use. It can discover all the iBoots on your network, display the current IP address of each, and allow setting of any valid IP address.

Install and Run the DMU

1. Download setup_dmu.exe
2. Run setup_dmu.exe
3. Run the DMU

Note: The DMU can only set the IP address within the first two minutes of powering up or rebooting the iBoot. The DMU will only work with iBoots on the same physical subnet as the PC.

Once running, click on Device | Discover to display all the iBoots on your network. The DMU will display the Location Name, product ID with Version, the current IP Address, and the MAC Address. Factory defaulted iBoots will display with the name **iBoot-G2P-xxxx** (xxxx is the last 4 segments of the MAC address). Factory default is DHCP, so the unit will have a DHCP assigned address. If assigned by DHCP then no changes to the IP Address are required. If no DHCP server was available, the address will be **192.168.1.254**

The IP address field also indicates the port for web access that is used by the iBoot. The standard port for web browser control is factory default Port 80.



DMU Program Icon after install

Name	Product ID	IP Address	Mac Address
iBoot-G2P-fa80	iBoot-G2+ v1.40.60	192.168.0.107:80	00:0D:AD:01:FA:80
iBoot-G25-21a6	iBoot-G25 v1.40.60	192.168.0.102:80	00:0D:AD:03:21:A6
iBoot-G2-4ca6	iBoot-G2 1.52.238	192.168.0.106:80	00:0D:AD:02:4C:A6
iBoot-PDU-b5d77d	iBoot-PDU v1.03.06072018	192.168.0.104:80	68:9E:19:B5:D7:7D

DMU Discovers Dataprobe Devices on Local Network

Change the IP Address

1. Click on the row containing the iBoot-G2+ to be set. The row will become highlighted.
2. From the menu select Set | Network Settings
3. Enter the IP Mode Static and select desired network setting, or Enter the IP Mode DHCP and allow the Network to assign the network information. Click OK when done.
4. A confirmation box is displayed. Click OK to clear the box.

Once the IP Address is set, other all other operational features of the iBoot-G2+ can be set up. Click on Discover again to refresh the display, highlight the desired iBoot-G2+ and click on Manage | Launch Browser. see [Web Setup section 7](#) to configure the iBoot.

The DMU can also be used to return an iBoot-G2+ to its Factory Default condition, or to reset an iBoot-G2+ admin password only. Highlight an iBoot-G2+ from the display and select Set | Factory Defaults, or Set | Admin Password. Depending on what you want to reset. These must also be done within the first two minutes of powering up or reboot of the iBoot.

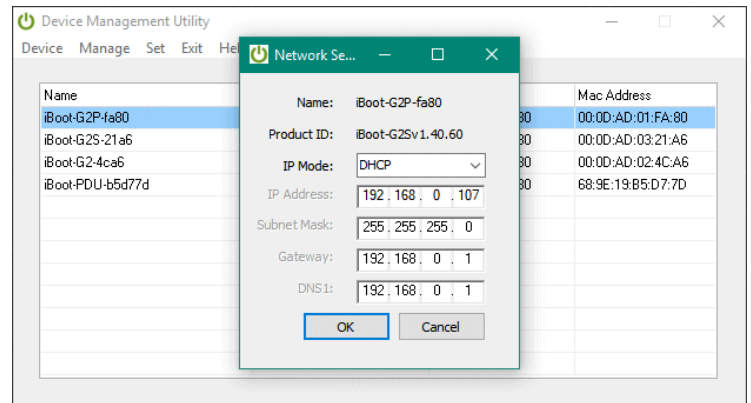

Enter New IP Address for iBoot

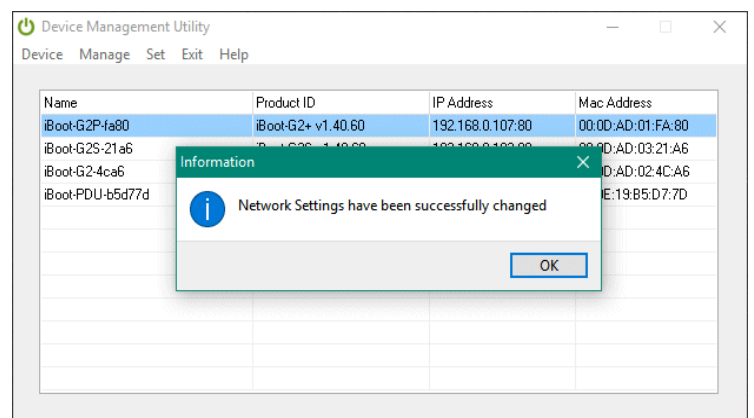

IP Address Successfully Set

5.3. Other ways to set the IP Address

1. Web Browser via the Set-up Page – see Network Settings [section 7.3](#)
2. Command Line Interface see iBoot-G2+ CLI Syntax [section 9.2](#)

6. Web Browser Operation

6.1. Password Protection

iBoot-G2+ uses two username/password credential sets, one for normal power control (User) and one that also provides access to the setup functions (Admin). This configuration can be changed to require Administrator credentials at all times or allow unsecured User level control. see Passwords / User Settings [section 7.13](#).

Default Credentials:

Role	Username (fixed)	Password (settable)
Administrator	admin	admin<last 3 MAC segments>
User	user	user<last 3 MAC segments>

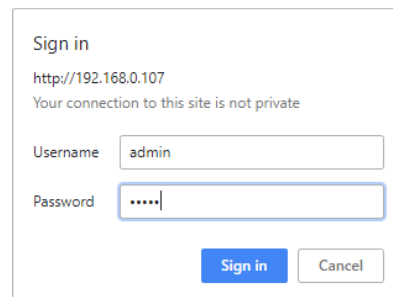

The passwords are unique and based on the last 3 segments of the MAC address of the unit. The MAC address can be found on a sticker on the bottom of the unit. Typical 00-0D-AD-xx-xx-xx. Example: If your MAC address is 00-0d-ad-aa-bb-cc then the admin password is adminaabbcc and the user password is useraabbcc.

Open your browser and enter the IP address of iBoot-G2+ into the address bar. If you have changed the IP address by any of the methods described, enter that address, otherwise, use the default IP address 192.168.1.254

Enter the username and password when prompted. When the proper username/password is received the Control and Status Page is displayed.

iBoot-G2+ uses an inactivity timer for security. This timeout is user selectable from 0 to 99 minutes. Setting to zero disables the timeout feature. When there is no activity for the set time in minutes, the user is automatically logged out and the username and password will need to be entered again for access. This is to prevent accidental lockout by leaving the user logged in.



As the iBoot-G2+ allows only one Web user logged in at any time, use caution when disabling the timeout feature, as it is possible to lock out other users by forgetting to logout. Closing the browser will not log the user out and will lock out web access. If you do become locked out, access the iBoot-G2+ via Telnet and reboot the unit, or press the reset button (see Section 11)



When accessing and using the iBoot-G2+ via a web browser, the browser session may remain authenticated even after logging out. For ultimate security, please close the browser to clear any authentication artifacts after logging out of the unit.

6.2. Mobile Browser Support

The web page displayed to the right is for screen sizes 700 pixels wide and less. The iBoot-G2+ automatically detects the screen size and adjusts the pages to look appropriate for the mobile browser. Setup options are available, however some settings will require the phone to be in portrait mode to be programmed.

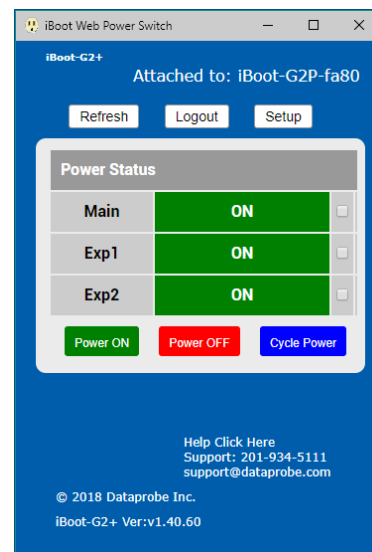

6.3. Control and Status Page

Once the user is validated, the Control and Status is displayed. (Only one person can be connected to the iBoot-G2+ at a time.)

The look of the Control and Status page will be determined by which options are selected for the Expansion, AutoPing and Heartbeat.

If the iBoot-G2+ is connected to a time server (see Time Setup [section 7.4](#)), The Home page will also show the five most recent history events, including the Outlet, Action, User and Time/Date of each event. The iBoot-G2+ holds the last 32 events in memory. The user can access a complete history webpage, download the history in a .csv file, or clear the history.

6.4. Power Status

The Power Status section shows the current status, and allows control of the power outlet(s). The look of the Power Status Section is determined by the setup of the Expansion feature.

Expansion Set for iBoot-Expansion:

The Power Status section shows the On or Off status of each of the three manageable outlets, Main, Exp1 and Exp2.

To control the power, select the desired outlets and click on the appropriate button. If an outlet is linked to the Main outlet, an **Linked to Main** message will replace the checkbox (as shown for Exp1) and it will be managed in sync with the Main Outlet.

A clock icon will indicate that the outlet has an active schedule for power control.

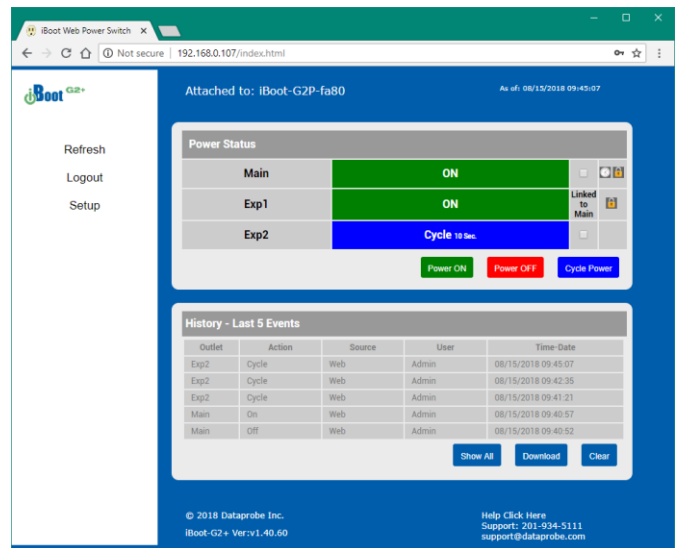

Expansion Set for Power Control

If the expansion ports are set for Power Control mode, and the inputs are currently controlling power, a Lock icon will be displayed, indicating that the outlet is locked by the external controls. While the inputs are controlling power, ALL other control is locked out. This allows for a local switch to lock an outlet On or Off.

During power cycling, the Power Status bar will indicate the temporary status, with a blue background. Once the cycle is complete, the status bar will revert to its original condition. To abort a power cycle, select the desired outlet and click on either Power On or Power Off buttons. iBoot-G2+ will assume the status selected

Expansion Set for Independent I/O Mode:

The Power Status section shows a single status for the Main outlet. Expansion ports 1 and 2 are displayed below in an External I/O section with a status of Open or Closed for the Input and Output of each. A button toggles the status of the output for Exp1 and Exp2.

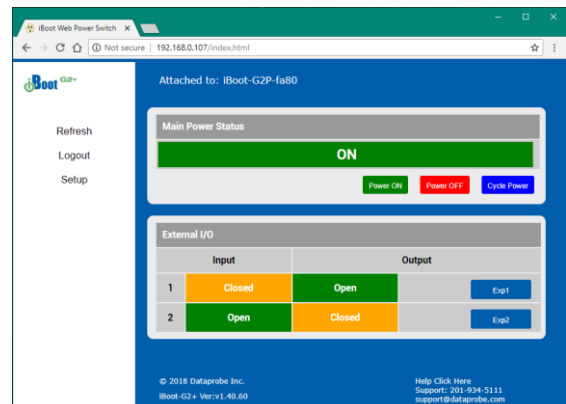

AutoPing Enabled:

If the AutoPing feature is in use, the page will also display the current status, OK or Failed, for each AutoPing used, with a counter showing how many times the Action was triggered. Reset button for the Trigger counters are provided.

Heartbeat Enabled:

If the Heartbeat feature is enabled, the page will display the current status, OK or Fail of the Heartbeat, with a counter showing how many times the Action was triggered. Reset button for the Trigger counter is provided.

Navigation Buttons:

Refresh: Use the Refresh button to obtain the latest status of iBoot. Using your browser's refresh button can lead to inadvertent power switching. If the time server is enabled, the time of the last refresh will be shown in the upper right corner.

Logout: When you are finished with iBoot, click on Logout. A Goodbye page will be displayed. This page has a URL link to re-connect with the iBoot. The linkback URL is user settable. If no linkback is set, the hyperlink will be the unit's IP Address.

Setup: To access the Setup page, the administrator credentials are required. When logged in as User, the challenge for Administrator credentials will be offered.

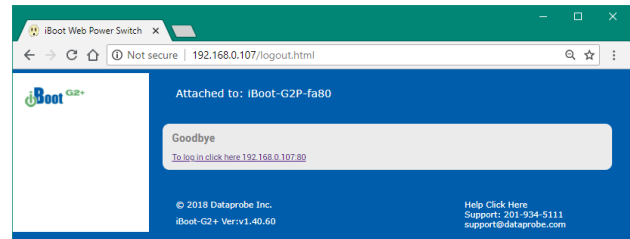
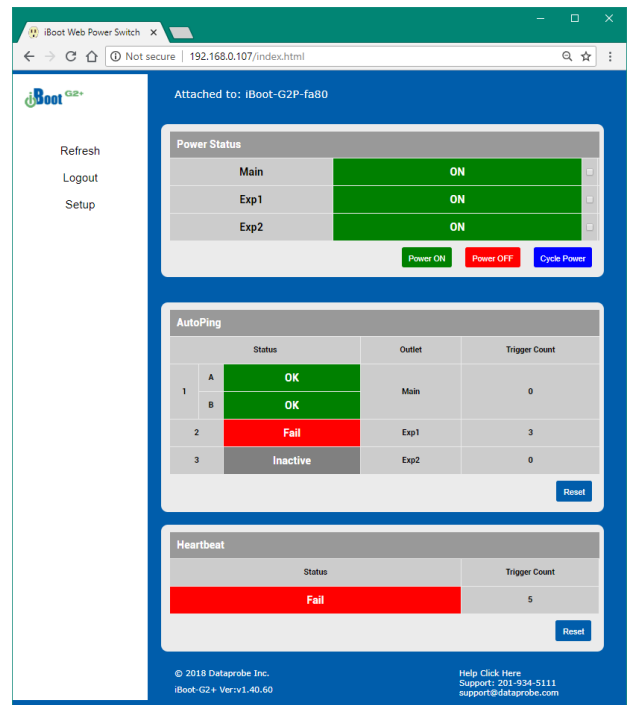

6.5. URL Control

iBoot-G2+ can be controlled directly by sending a completely formed URL through a browser window or HTTP command. The URL syntax for control is:

http://<address>?c=<channel>&s=<status>&t=<time>&u=<user>&p=<password>

Where:

<address> = the IP Address of the device, or DNS name that resolves to the IP Address, Including any HTTP Port if not standard 80

<channel>= The Channel or outlet to control
1 = Main ; 2 = Exp1 ; 3 = Exp2

<status> = The status to change the outlet to:
0 = Off ; 1 = On ; 2 = Query only, no outlet change

<time> = The amount of time to cycle

<user> = user or admin depending on password used

<password> = password associated with user

Syntax notes:

- The order of the variables is not significant.
- The user and password are not required when Auto-Login feature is enabled (see Passwords / User Settings [section 7.13](#) for security options.)
- No channel is required when requesting status (including is OK)

Examples:

<http://192.168.1.254?c=1&s=1&u=user&p=user>

Turn Main outlet on for the default user.

<http://192.168.1.254?c=1&s=0&t=5>

Reboot Main for 5 seconds with Auto-Login

<http://192.168.1.254:8080?s=2&u=admin&p=admin>

Return status using http port 8080

URL Command Responses

iBoot-G2+ will return a response to a **URL command** as follows:

<location id> Command Received

The full http response is

```
<!DOCTYPE html PUBLIC "-//W3C//DTD XHTML 1.0 Transitional//EN"
"http://www.w3.org/TR/xhtml1/DTD/xhtml1-transitional.dtd">
<html xmlns="http://www.w3.org/1999/xhtml">
<head>
<meta http-equiv="Content-Type" content="text/html; charset=utf-8" />
<title>iBoot Status</title>
</head>
<body>
<locationID>iBoot-G2-Plus</locationID>
<status>Command Received</status>
</body>
</html>
```

iBoot-G2+ will return a response to a **URL Status Request command** as follows:

<location id> <Main status>,<Exp1 status>,<Exp2 status>

The full http response is

```
<!DOCTYPE html PUBLIC "-//W3C//DTD XHTML 1.0 Transitional//EN"
"http://www.w3.org/TR/xhtml1/DTD/xhtml1-transitional.dtd">
<html xmlns="http://www.w3.org/1999/xhtml">
<head>
<meta http-equiv="Content-Type" content="text/html; charset=utf-8" />
<title>iBoot Status</title>
</head>
<body>
<locationID>iBoot-G2-Plus</locationID>
<status>ON,ON,ON</status>
</body>
</html>
```

7. Web Setup

iBoot-G2+ setup section consists of several pages. Access any page via the buttons on the left of the page. Each time a setting is changed click on the Save button for that page to save the changes before moving to the next page.

7.1. Device Settings

Location ID: Set a 20 character name to be displayed on the top of the home page. This assists in identifying which iBoot-G2+ is being accessed. This name is used for LLNMR. see Local Link Multicast Name Resolution (LLMNR) [section 7.15](#). The name is also transmitted to the cloud on registration to a cloud account. see iBoot Cloud Service [section 8](#).

Delay Time: 0 to 999 seconds delay time. When powering up multiple devices, a delay can be set between each outlet.

Outlet Name: Set an independent 20 character name to be displayed for each of the Main, Exp1 and Exp2 Outlets.

Cycle Time: 0 to 999 seconds power cycle time. This is the length of time the power will be off during a reboot, or on during a power burst. Unique cycle times can be set for Main, Exp1 and Exp2.

Initial State: Each outlet can be set to the state it will assume when the iBoot-G2+ is powered up or reset. The choices are: On, Off and Last, meaning the state it was in when the power was removed or reset commenced.

Upgrade Enable: Check this box to allow remote firmware upgrades of the iBoot-G2+. When this box is unchecked, firmware upgrades will not be allowed. When checked, upgrade must occur within 2 minutes of power up or after a reboot is complete.

Auto Logout: This setting sets the automatic logout for inactivity on both the web and telnet users. It can be set from 0 to 99 minutes. 0 disables the Auto Logout feature.



As the iBoot-G2+ allows only one Web user logged in at any time, use caution when disabling the timeout feature, as it is possible to lock out other users by forgetting to logout. Closing the browser will not log the user out and will lock out web access. If you do become locked out, access the iBoot-G2+ via Telnet and reboot the unit, or press the reset button.

The screenshot shows the 'iBoot Web Power Switch' web interface. The browser address bar shows '192.168.0.107/set_device.html'. The page title is 'Attached to: iBoot-G2P-fa80'. The 'Device Settings' form includes the following fields and options:

- Location ID: iBoot-G2P-fa80
- Delay Time: 1 Seconds
- Disable Off:
- Outlet Name: Main, Exp1, Exp2
- Cycle Time: 10 Seconds, 10 Seconds, 10 Seconds
- Initial State: Last, Last, Last
- Upgrade Enable:
- Auto Logout: 2 Minutes

Buttons: Reset, Save

Footer: © 2018 Dataprobe Inc. iBoot-G2+ Ver:v1.40.60 Help Click Here Support: 201-934-5111 support@dataprobe.com

7.2. Expansion Settings

Mode: The iBoot-G2+ has three modes of operation for the expansion, each with its own set of settings.

- iBoot Expansion Units: For use with the iBoot-EXP expansion units.
- Independent I/O: Inputs and outputs are used as status and control not associated with power outlets.
- Power Control: For use with external switches to provide manual power control.

Features are dependent on which mode is selected

iBoot Expansion Units

This mode is default and is used with the iBoot-EXP devices. The Main page will show status and allow control for the Main, Exp1 and Exp2 outlets.

Hide from Status and Control: Independently hide the status of Exp1 and Exp2 from the Main Status and Control webpage. Checking the box to hide the status is available as an option should you not be using the expansion capabilities of the iBoot-G2+ device. Hiding the status does not prevent the function of Expansion units should they be attached. This allows for linked outlets to be hidden, but still function.

Link to Main: Checking the box for Link to Main will independently make the status of the Expansion unit be identical to the Main outlet of iBoot-G2+. This is convenient if switching both power supplies of dual redundant powered devices. The delay time will apply.

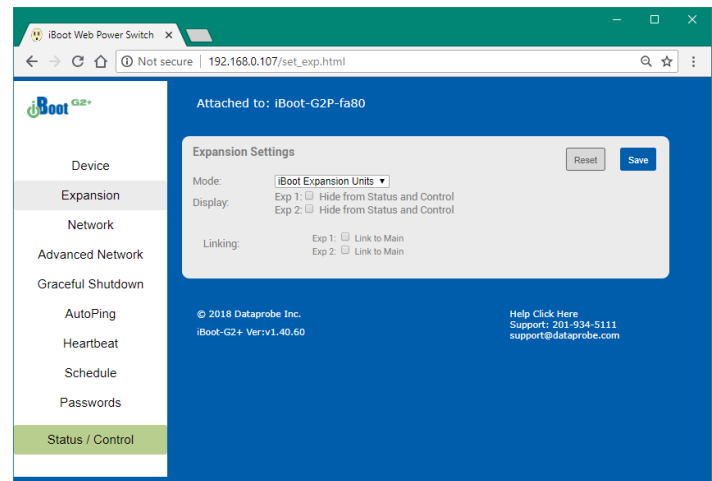

Independent I/O

This mode will display the input and output status for Exp1 and Exp2 on the status and control page. The open collector design of the output connectors can be used to control non-Dataprobe devices, or connected to a Dataprobe external relay module to allow relay control of those devices. The input status can also be used to control Dataprobe devices that support DxP protocol. Allowing a switch connected to the Exp connector to control a remote Power Outlet or relay on any DxP controlled device.

Hide from Status and Control: Independently hide the status of Exp1 and Exp2 from the Main Status and Control webpage. Checking the box to hide the status is available as an option should you not be using the expansion capabilities of the iBoot-G2+ device. Hiding the status does not prevent the function of I/O should connections be attached or programmed.

To allow the inputs of Exp1 and Exp2 to control additional devices via DxP Protocol, enter the IP address, relay number, user name and password for the device to be controlled.

See Expansion Connections [section 4.3](#) for details on the Exp connectors and the open collector output.

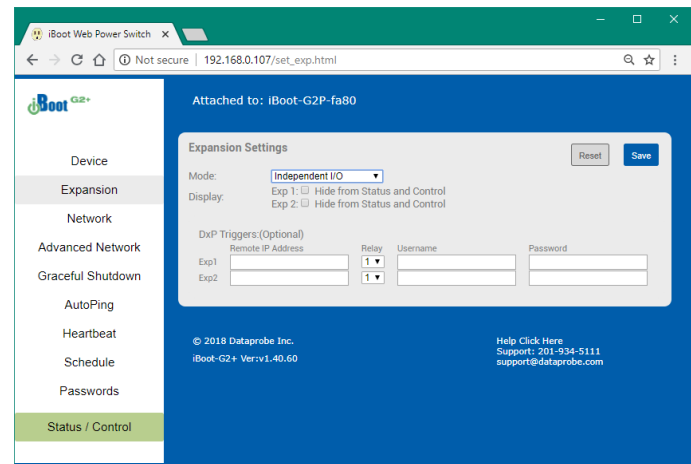

Power Control

In this mode, each of the two inputs is independently set. Select the target outlet, Main, Exp1 or Exp2 and the action desired with the input is Closed. The choices for action are:

- On Turn the power On
- Off Turn the power Off
- Cycle Change the power for the Cycle Time setting
- Toggle Change the state of the power. From Off to On or On to Off, depending on current state.

Hide from Status and Control: Independently hide the status of Exp1 and Exp2 from the Main Status and Control webpage. Checking the box to hide the status is available as an option should you not be using the expansion capabilities of the iBoot-G2+ device. Since the Power Control mode only uses the inputs of the Exp connectors, the iBoot-EXP expansion outlets could still be connected and controlled. Hiding the status does not prevent the function of inputs or outputs should connections be attached or programmed.

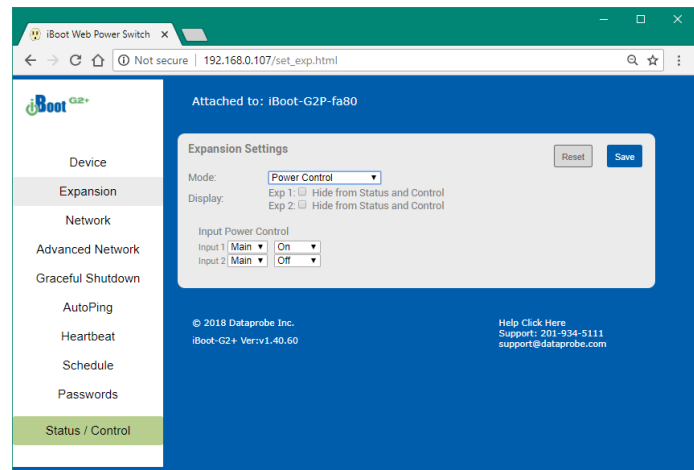

The power is controlled when the input is connected to ground. This makes momentary switches preferred for power control. Leaving a connection closed when using Cycle or Toggle controls will not affect the function of the outlet or harm the device, but it will require you to open the switch and re-close for the next power control event. When programmed to use On or Off controls, holding the input to ground will lock the power in the selected position allowing for manual override of all other control options. So a non-momentary switch may be desirable if locking the outlet status is what is required. When an outlet is Locked by the input, the status and control will display a lock icon next to the outlet.

By using both inputs, one set for On and the other for Off, you can use a three position switch to create a wired Remote On - Off switch. Allowing local control as well as the remote network control methods.

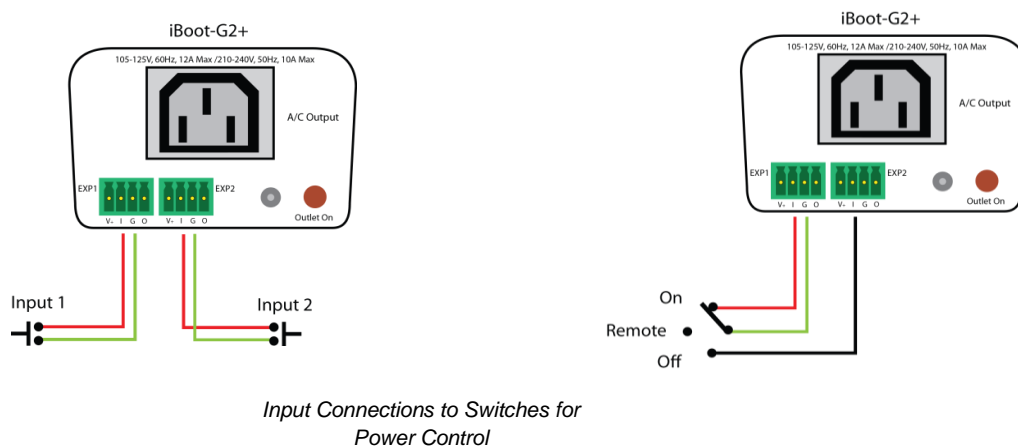

7.3. Network Settings

IP Mode: Select Static to set the IP address using the fields below, or DHCP to allow a DHCP server to set the IP Address.

IP address: Enter a static IP address. This will be automatically set if using DHCP.

Subnet Mask: Enter the Subnet Mask. This will be automatically set if using DHCP.

Gateway: Enter the Gateway. This will be automatically set if using DHCP.

DNS: Enter the Domain Name Server. This will be automatically set if using DHCP.

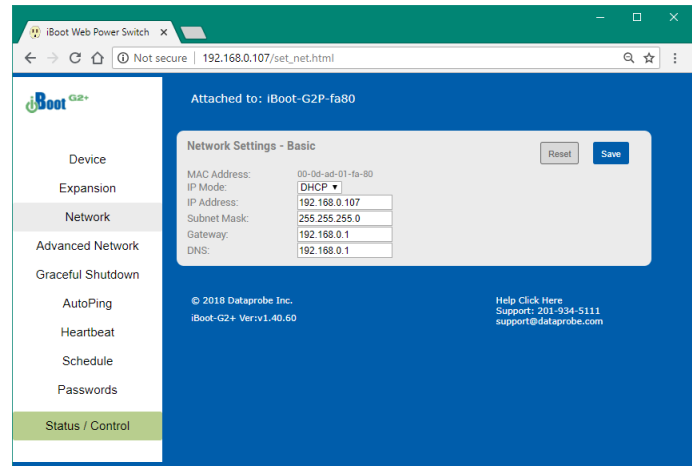

7.4. Advanced Network Settings

HTTP Port: This setting is used to allow access to iBoot-G2+ on a port other than the Web standard Port 80. If the port is changed, you will need to identify the protocol and port number when you enter iBoot's IP address into your browser. If the new port is 8080 then use the URL would be <http://192.168.1.254:8080>.

Linkback URL: This setting allows control of the hotlink displayed on the Goodbye page. It allows use of the public IP address or DNS name instead of the internal IP Address of the iBoot-G2+, which is the default setting. If this setting is left blank, the hotlink will be the IP Address of the unit.

Note: You should **not** include the `http://` part of the URL. If you set any HTTP Port other than Web standard 80, you must append to the URL. examples: [myiboot.com] [myiboot.com:8080]

Telnet Port: This setting is used to allow access to the iBoot-G2+ via telnet by ports other than standard 23.

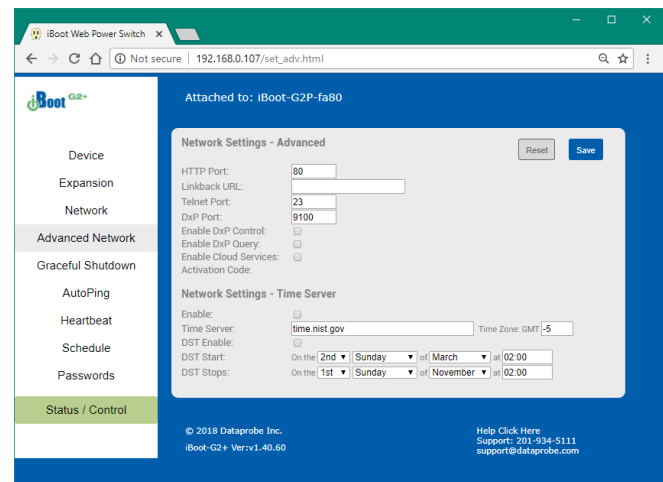

DxP Port: This setting is used to allow access to the iBoot-G2+ via Dataprobe Exchange Protocol (DxP) using ports other than standard 9100. see DxP Protocol [section 10](#).

Enable DXP Control: This setting enables external devices to control the iBoot-G2+ via DxP protocol.

Enable DXP Query: This setting enables external devices to query the status of the iBoot-G2+ via DxP protocol.

Enable Cloud Services: This setting enables the iBoot-G2+ for iBoot Cloud Services (iBCS). iBCS allows the iBoot to be monitored and controlled through a web portal from any browser. It allows multiple iBoots to be managed from a single portal without the need for port redirection or a static public ip address. For a complete description of iBCS and setup instructions, see iBoot Cloud Service [section 8](#).

Note: All of the TCP/IP Settings require a reboot of the iBoot-G2+. After clicking Save, a Reboot button will appear next to the Reset and Save buttons near the top of the page. The new settings will not take effect until the unit is rebooted. Reboot will not affect the power position of the iBoot-G2+. Upon Clicking Reboot, the goodbye page is displayed with a link to re-login.

Time Setup

These settings enable the iBoot-G2+ to get a valid time and date from a time server. Valid time and Date are required for Historical log and Scheduled events to be accurate. The unit will need proper network parameters to allow internet access and access the default time server at time.nist.gov

Enable: This checkbox when checked will enable the time server.

Time Server: This field is for the desired time Server to be accessed. time.nist.gov is the default. You may enter a Domain Name or ip in this field.

Time Zone: This field is for the Time zone of the unit. (valid is -12 to 12) Default is -5 EST.

DST Enable: This checkbox when checked will enable the Daylight Saving Time settings. (Southern Hemisphere DST is supported)

DST Start: These settings will signify the start time for Daylight Savings Time
Default is 2nd Sunday of March at 02:00

DST Stops: These settings will signify the stop time for Daylight Savings Time
Default is 1st Sunday of November at 02:00

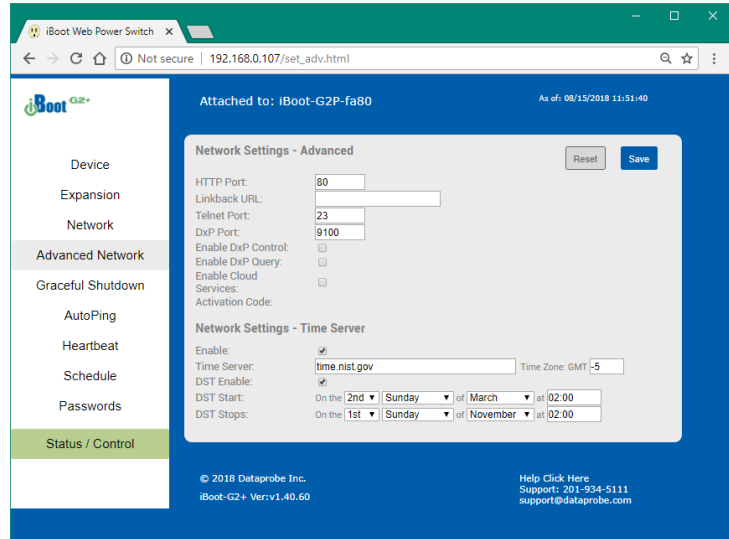

The screenshot shows the iBoot-G2+ web interface. The browser address bar displays "192.168.0.107/set_adv.html". The page title is "Attached to: iBoot-G2P-fa80" and the timestamp is "As of: 08/15/2018 11:51:40". The interface is divided into a left sidebar and a main content area. The sidebar contains a menu with items: Device, Expansion, Network, Advanced Network (selected), Graceful Shutdown, AutoPing, Heartbeat, Schedule, Passwords, and Status / Control. The main content area is titled "Network Settings - Advanced" and "Network Settings - Time Server". The "Advanced Network" section includes fields for HTTP Port (80), Linkback URL, Telnet Port (23), and DxP Port (9100). There are checkboxes for "Enable DxP Control", "Enable DxP Query", and "Enable Cloud Services". The "Time Server" section has an "Enable" checkbox checked, a "Time Server" field containing "time.nist.gov", and a "Time Zone" dropdown set to "-5". The "DST Enable" checkbox is also checked. The "DST Start" is set to "On the 2nd Sunday of March at 02:00" and the "DST Stops" is set to "On the 1st Sunday of November at 02:00". At the bottom, there is copyright information for Detaprobe Inc. and a support link.

7.5. Graceful Shutdown

The iBoot-G2+ is capable of attempting a graceful shutdown of Windows based PCs and servers (XP and later) prior to performing a hard reboot or power down. Activate and control the performance of this feature on this page. Use of graceful shutdown requires installation of the iBoot Utility, which can be found at dataprobe.com/support-iboot-g2-plus.

Graceful Shutdown affects all modes of control of the iBoot-G2+, including the manual switches, when the expansion ports are used in Power Control mode.

For each of the three controllable outlets set;

Enabled or Disabled Checked is enabled.

IP Address. Enter the IP Address of the target system. (PC running the iBoot Utility)

Username and Password. Enter a username and password exactly as they were entered in the iBoot Utility on the target system.

Hard Shutdown Delay. When selecting Off from any control method, this is the time, in seconds for the iBoot-G2+ to wait for the graceful shutdown to be successful and complete. After this time, successful or not, the iBoot-G2+ will power down the selected outlet.

Hard Reboot Delay. When an outlet is On, and you select cycle from any control method, this is the time, in seconds for the iBoot to wait for a graceful reboot to successfully complete. If the graceful reboot is successful within this time, the iBoot Utility will start on the target PC, and inform the iBoot-G2+ that the reboot completed successfully. This message will cause the iBoot to **NOT** perform a hard reboot of the selected outlet. If the iBoot-G2+ does not receive the successful reboot message from the iBoot Utility, the iBoot-G2+ **WILL** perform a hard power cycle of the outlet. (Using the cycle time as programmed in the Device section)

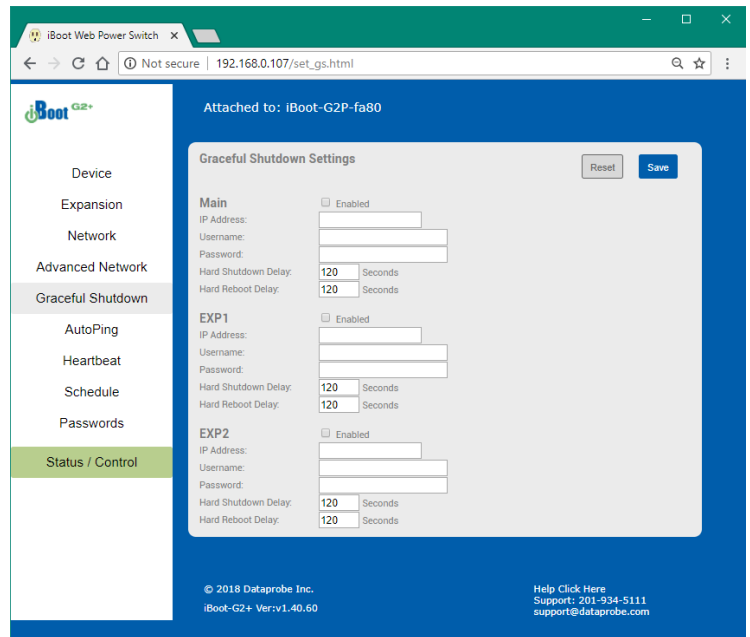

7.6. AutoPing

The AutoPing feature allows iBoot-G2+ to automatically detect failed equipment and perform a timed reboot or other power control function (like turning on an indicator or siren). You can program up to four IP addresses to be periodically pinged. When iBoot-G2+ no longer detects a response from these addresses, the programmed power control function is actuated.

Three separate AutoPing functions are provided and act independently of each other. AutoPing 1 can use two Addresses, which can be AND or OR linked so that both (AND) or either (OR) need to fail in order to take the selected action.

AutoPing 2 and AutoPing 3 are independent single address functions.



Examples:

Use AutoPing as server monitor: iBoot-G2+ is installed with the device it monitors and automatically reboots if there is no response. Ideal for: Kiosks & Servers



Use Auto-Ping as service monitor: iBoot-G2+ is installed with the device to be rebooted, but pings a remote host to test the communication channel. Ideal for: DSL & Cable Modem Verification

iBoot-G2+ monitors network device and powers up alarm or redundant system when there is no response. Ideal for: Hot Standby Servers, Environmental Control, Alert for any Network Failure

iBoot-G2+ supports three independent AutoPing channels, each controlling either the Main power, or either of the two Expansion ports. The first AutoPing channel can be programmed with two separate IP Addresses with logical AND / OR comparisons to determine the final action.

7.7. AutoPing Settings

Address: Enter the address of the device to be pinged. This can be a Domain name or an IP Address

Ping Frequency: Enter 1 to 999 seconds. The ping will go out to the selected device this often.

Fail Count: Enter 1-999 times the ping needs to fail consecutively before the selected action is taken. When the fail count has been reached, the AutoPing action will be triggered.

Mode: (AutoPing 1 only) Select from A Only, A And B, A Or B. With **And**, both AutoPings need to exceed their fail count to trigger the Action. With **Or**, the Action will be triggered if either AutoPing fails.

Control: Select Main for the internal power outlet, or Exp1, Exp2 for either of the two expansion ports.

Action: Select from

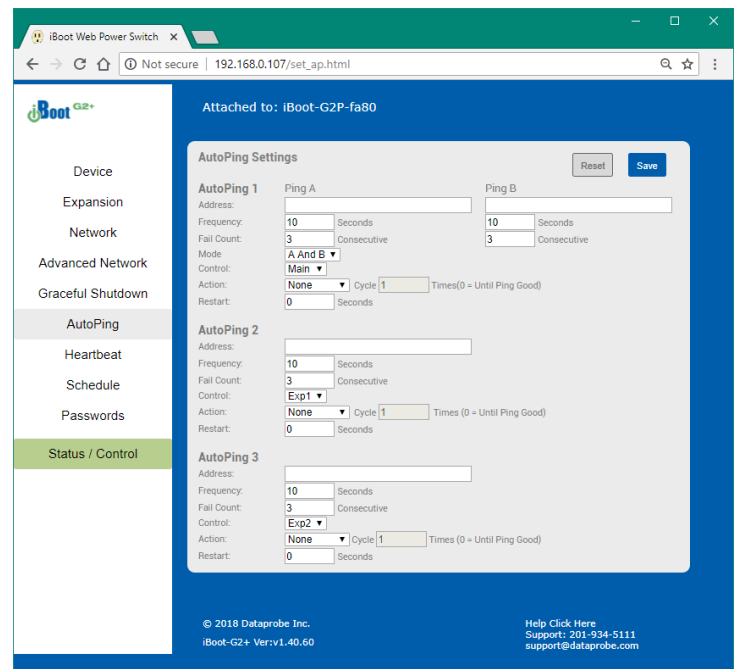

None	AutoPing will not take any action upon Fail.
On – Latch	Upon triggering, iBoot-G2+ will power on and remain on until changed via the web, telnet, DxP, etc.
On – Follow	Upon triggering, iBoot-G2+ will power on. When the ping response returns, iBoot-G2+ will power off.
Off – Latch	Upon triggering, iBoot-G2+ will power off and remain off until changed via the web, telnet, DxP, etc.
Off – Follow	Upon triggering, iBoot-G2+ will power off. When the ping response returns, iBoot-G2+ will power on.
Cycle (Cycle) Times	Upon triggering, iBoot-G2+ will cycle the power. If Power Cycle does not result in the ping response the iBoot-G2+ can cycle again. The number of times the iBoot-G2+ will cycle is set by the Times setting. To have the iBoot cycle power 3 times to get the system to respond again, set the Times to 3.

Restart: After autoping Fails, and an action occurs, the restart time is the length of time the iBoot-G2+ will wait before restarting to ping again.

With AutoPing operational, the main iBoot-G2+ page will display the current status of this feature. The status will be OK to indicate that iBoot-G2+ is receiving responses to the ping, or that the fail counter has not yet been exceeded.

If the fail count has been exceeded, the status will change to FAIL. The Trigger Counter indicates the number of times the AutoPing action has been triggered. A counter reset button is provided.

7.8. Heartbeat

Like AutoPing, the Heartbeat monitor allows iBoot-G2+ to automatically detect failures in critical devices. With the Heartbeat monitor enabled, iBoot-G2+ will expect a message, either from the USB port or network at regular intervals.

When it misses a user defined number of intervals, it will perform its programmed action.

Use the heartbeat to insure that you server is running. When the server crashes, it will be automatically rebooted.

The heartbeat can be generated in any of several ways;

- Using the iBoot Utility.
- A Windows .dll file is also available for use by Windows applications.
- The Heartbeat Protocol will allow developers to imbed this capability directly into their software products.

All of the above are available at dataprobe.com/support-iboot-g2-plus

7.9. Heartbeat Settings

Source : Select the source of the heartbeat, either USB, Network or None (heartbeat not used). When using the Network, enter the Port to expect the heartbeat. The default is 9100. (If Time Server is enabled, port 9100 can not be changed, and 9100 is used)

Frequency: Enter 1 to 999 seconds. If the heartbeat is not received within this time it will increment the counter.

Fail Counter: Enter the number of times (1-99) the heartbeat needs to fail before the selected action is taken. When the fail counter is reached, the heartbeat action will be triggered.

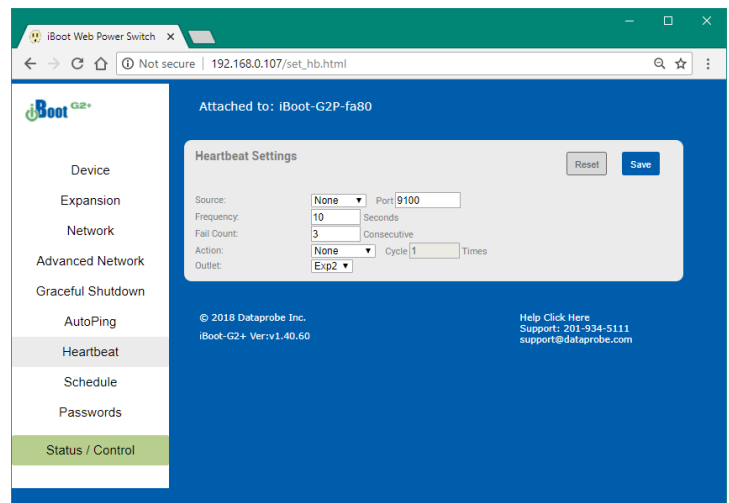
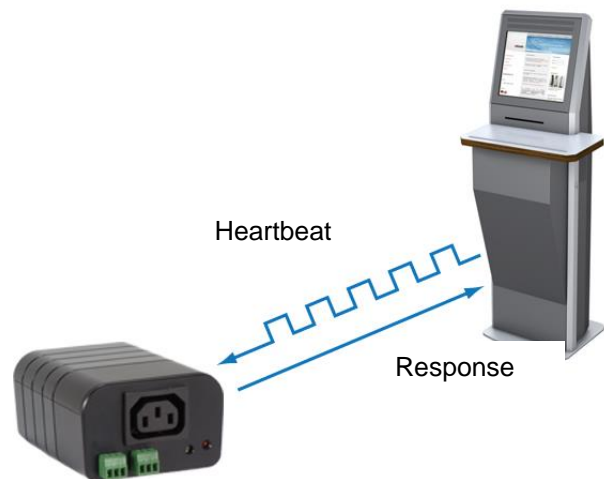

Action: select from

None	Heartbeat will not take any action upon Fail.
On – Latch	Upon triggering, iBoot-G2+ will power on and remain on until changed via the web, telnet, DxP, etc.
On – Follow	Upon triggering, iBoot-G2+ will power on. When the ping response returns, iBoot-G2+ will power off.
Off – Latch	Upon triggering, iBoot-G2+ will power off and remain off until changed via the web, telnet, DxP, etc.
Off – Follow	Upon triggering, iBoot-G2+ will power off. When the ping response returns, iBoot-G2+ will power on.
Cycle (Cycle) Times	Upon triggering, iBoot-G2+ will cycle the power. If Power Cycle does not result in the ping response the iBoot-G2+ can cycle again. The number of times the iBoot-G2+ will cycle is set by the Times setting. To have the iBoot cycle power 3 times to get the system to respond again, set the Times to 3.

Outlet: Select Main for the internal power outlet, or Exp1, Exp2 for either of the two expansion ports.

7.10. Using Heartbeat Monitor

With Heartbeat operational, the main iBoot-G2+ page will display the current status of this feature. The status will be OK to indicate that iBoot-G2+ is receiving heartbeats, or that the fail counter has not yet been exceeded.

If the fail count has been exceeded, the status will change to Triggered. The Trigger Counter indicates the number of times the Heartbeat feature has been triggered. A counter reset button is provided when logging in with the System password.

7.11. Using the iBoot Utility

The heartbeat creating is a feature built into the iBoot Utility program and instructions are available at dataprobe.com/support-i-boot-g2-plus

7.12. Event Scheduling

iBoot-G2+ can schedule up to fourteen reoccurring power events. Set the starting date and time, any repeat cycle, the action to be taken and outlet to use for each.

To enable the time scheduling function:
See Advanced Network Time Setup [section 7.4](#).

Once the time server is active, scheduled events can occur. Up to fourteen independent scheduled events can be programmed.

Date: Set the initial date for the event. The format for the date is mm/dd/yyyy.

Time: Set the initial time for the event. The format for the time is hh:mm with hours in 24 hour format.

Repeat: Set the repeat multiplier, if desired. Set the number from 0 to 999 and either Days, Hours, or Minutes. To have the schedule repeat every two days, set this number to 2. To run only once, set this to 0.

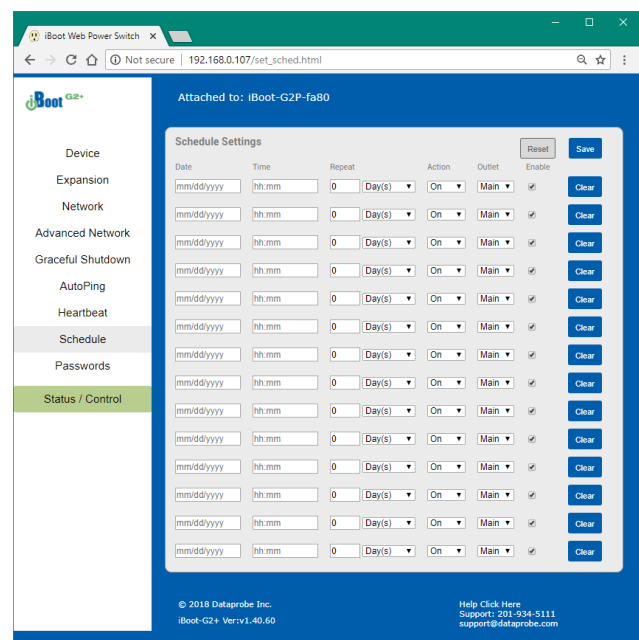

Action: Set the event Action; On, Off or Cycle.

Outlet: Set the outlet to be controlled by the event. If Expansion units are linked to Main, controlling Main will also control the linked Expansion Unit.

Enable: When checked the event is enabled. Unchecked the event is disabled. A disabled event will not control power, but will recalculate the next attempt should the Date and Time pass when it would have taken place.

Clear: Clear the scheduled event. (Delete programmed parameters from list)

Click Save to save the current settings. Click Reset to delete any unwanted changes.

7.13. Passwords / User Settings

The iBoot-G2+ supports three modes of user and password operation.

Login Required: This mode supports both User and Admin users. Each user has a settable password.

Auto Login: This mode does not require a username or password for the User level operation. No login challenge will be required for any mode of operation, until any setup function is requested. The Admin username and password is required for any admin functions.

User Disabled: There is no User account. The Admin username and password will be required for operation and setup functions across all modes of operation. This is the factory default mode.

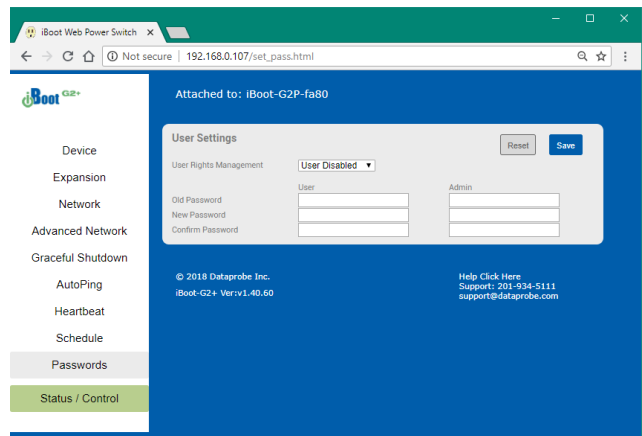

Two passwords are used by iBoot. In the Login Required mode, The User Password allows access to the control of iBoot, but not to the Setup functions. Clicking on the Setup button allows the Administrator to log in. Passwords can be up to 20 characters long and are case sensitive.

Enter the current password then the new password twice to confirm.

Default Credentials

Role	Username (fixed)	Password (user set)
Administrator	admin	*adminxxxxxx
User	user	*userxxxxxx

*The passwords are unique and based on the MAC address of the unit. (the xxxxxx are the last 3 segments) The MAC address can be found on a sticker on the bottom of the unit. Typical 00-0D-AD-XX-XX-XX. Example: If your MAC address is 00-0d-ad-aa-bb-cc then the admin password is adminaabbcc and the user password is useraabbcc.

7.14. Disable OFF

This new feature in iBoot-G2+ version 1.40 and above insures that the power to the controlled device will always be on whenever possible. No accidental turning or leaving the power off is possible.

To use the “Disable Off” feature

WEB – On the Setup > Device page check the enable box next to the Disable Off: option and Save.

CLI - telnet to the unit and issue the Command Line Interface command.

```
set disable off yes
```

Use the following to determine the current status of the feature.

```
get disable off
```

The response will be **Disable Off: Yes** or **Disable Off: No**

Yes will indicate it is enabled and No will indicate it is disabled. By default, the feature is disabled.

To stop using this feature issue the command

```
set disable off no
```

When the feature is enabled, the following will occur:

- If the outlet is Off at the time the feature is enabled, the outlet will turn On
Initial state will be programmed for On
- Initial state will not allow programming for Off or Last
- If AutoPing action programmed for On-Follow, Off-Latch or Off-Follow, the autoping action will be reprogrammed as None
- AutoPing action will not allow programming for On-Follow, Off-Latch or Off-Latch
- If a Schedule Settings event has action for Off, it will be reprogrammed for On
- Schedule Settings will not allow programming for action Off
- Web page will not show the “Power OFF” button
- Web Page will not process an HTTP POST for Off.
- URL control will not process an unqualified off status request (s=0) A qualified off status request with a time setting (s=0&t=1) of 1 or more will be processed allowing for URL control to cycle off, then back on
- URL control will not process a qualified on status request with a time setting (s=1&t=1) of 1 or more (disabling URL control to cycle on then off)
- DxP control will not process an Off command
- DxP control will not process a pulse on command. pulse on commands end with outlet off
- DxP control Pulse Off commands, while in progress, will not allow cycle commands to override them. (avoiding potentially having a completed cycle end as off)
- Cycle commands, while in progress, will not allow new cycle commands to override them. (avoiding potentially having a completed cycle end as off)
- Command Line Interface (CLI) control will not process “set outlet off”
- If cloud control is enabled, the Off command will not be processed.

Disabled

When the feature is disabled, all the modes that can turn the power off will be available and functioning.

7.15. Local Link Multicast Name Resolution (LLMNR)

The Link-Local Multicast Name Resolution (LLMNR) is a protocol based on the Domain Name System (DNS) packet format that allows hosts to perform name resolution on the same local link.

On most networks you will be able to access the iBoot-G2+ by its device name when on the local network.

By default the name is iBoot-G2-xxxx where the xxxx is the last 4 segments of the MAC address for your iBoot-G2. When you reprogram the name of the device, a reboot is required to apply the new name as the LLMNR for the device.

The LLMNR name does not allow spaces. If using the LLMNR feature to access the iBoot-G2, do not use a space in the name. When accessing the device type the complete URL including the http:// if you need to avoid searching the internet for the name. (<http://iBoot-G2-xxxx>)

When the Location ID is changed the device will require a reboot to re-register the new name to your networks llmnr server. This means access using <http://iboot-g2p-fa80> should work, or a renamed myiboot would be accessible as <http://myiboot> . To make use of llmnr, you must choose a name with no space or special characters. (dashes are allowed)

8. iBoot Cloud Service

iBoot Cloud Service (iBCS) allows customers with iBoot-G2 Series devices to access and control multiple iBoots in multiple locations from a single portal with a single sign-on.

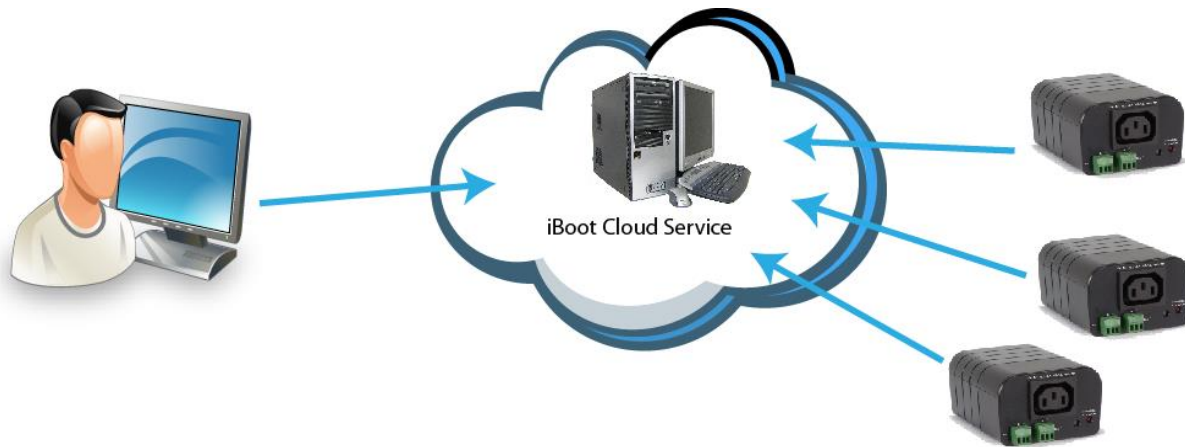

iBCS will not only make using iBoots easier, by consolidating all units into one sign-on and interface, it will also enhance the number of situations where iBoot can be deployed.

- Customers with Dynamic IP addressing will always be able to access their iBoot from any location.
- Customers that do not allow in-bound connections can access their iBoots.
- Service providers can manage multiple customer accounts with diverse security configurations

iBoot Cloud Service is made available to our current users free of charge, and is evolving. Screenshots below may be improved as time has passed since development of this manual. The full Terms of Service of the iBoot Cloud Service is [available here](#).

8.1. iBCS Setup & Operation

Use of the iBoot Cloud Services requires the iBoot to be configured to access the Internet. Please review the installation and configuration procedures to insure proper setup.

Hardware Installation [section 4](#) and Initial configuration [section 5](#)

a. Establish Account with iBoot Cloud Server

- Visit <https://iboot.co> from your browser
- Click on Register
- Complete the information
- Confirm Registration by clicking on the link provided in the email.

b. Enable Cloud Services on iBoot

- Log into the iBoot with Administrator rights
- Go to the Advanced Network Setup page
- Check Enable Cloud Services, and Save:
- Within 30 seconds, an 8 character activation code will appear.
- This code is also a hotlink to the Cloud Service.

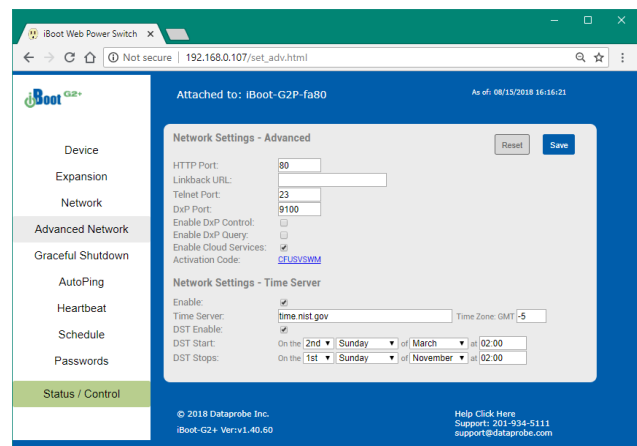

c. Register iBoot with Cloud Account

Click on the Activation code to register the iBoot with the Service.

You will be re-directed to the Service. Log-in with your account and the iBoot will be automatically registered with your account.

Alternatively, you can log in to the Service and click on Add | Device and enter the activation code in the field provided.

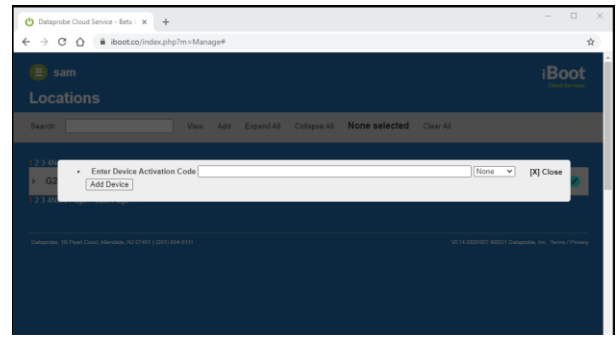

d. iBCS Main Page

The iBCS main web page provides an Icon for Account Settings The Accounts Settings Icon. will show:



Notification Settings: Where and When to send offline and online stats changes

Account Settings: Account Login Information including Multiuser Mode and LDAP settings

Logout: Log out of the Interface

The iBCS will also provide a Navigation Bar and it will show the following:

Search: Search for Devices or Locations

View: Locations, History or Support

Locations: Group iBoots by location.

History: Shows a history of account access.

Support: Will open a new tab to the support pages

Add: Device and Location names can be added

Device: Enter the Activation Code

Location: Create a new cloud location

Expand All: All locations visible will be expanded

Collapse All: All locations visible will be collapsed

or None selected: number of outlets selected

Clear All: De-Select all outlets

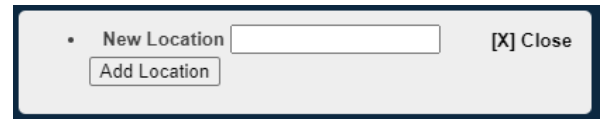
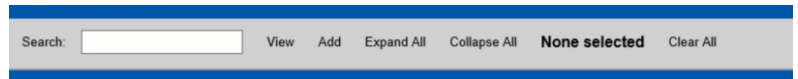

e. Control Power from the Cloud

The status screen will detail available iBoots registered with the cloud. You can add locations and group iBoots by location.

Each iBoot displays its power status and when expanded, the AutoPing status if configured.

Select an outlet and then the On, Off or Cycle button that will appear in the Navigation bar.

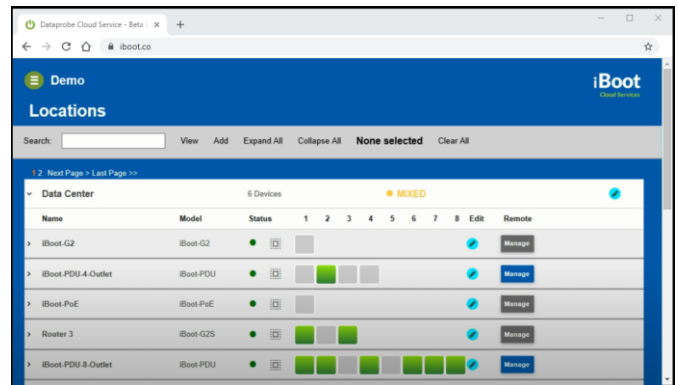

f. Assign Names and Locations

You can establish multiple locations and assign multiple iBoots to a location.

To add locations, click Add Locations from the Navigation bar. Name the location and Add Location button.

To rename or relocate an iBoot, Click the Edit icon for the iBoot.



g. Use Website for more help

Navigate to this page for helpful videos and other guides.

<https://dataprobe.com/iboot-cloud-service/>

Command Line Interface

The iBoot-G2+ Command Line Interface (CLI) provides a text based method for communicating with the iBoot-G2+. The syntax of the CLI uses basic Set (change a variable) and Get (retrieve a variable). The CLI is accessed either through the Telnet protocol, which requires a Telnet client program, or via USB which requires a serial communications program. Windows 10 does not include a pre-installed telnet or serial client. You must enable them within Windows, or use available alternate programs.

Dataprobe has developed a free telnet and serial utility called EZ Terminal. Download is available here: dataprobe.com/support/shared/ezterm.exe

8.2. CLI Access

Via Telnet

Open your Telnet client and connect to the IP address set for the iBoot-G2+.

Via USB

Open the console client and connect to the COM port assigned to the iBoot-G2+. The communications parameters are: 9600bps. 8 data bits. No parity. 1 Stop bit. No Flow Control. Once the connection is made, send Enter.

The CLI uses the same security options as the web browser. See Passwords/User Settings [section 7.13](#) for an explanation of the options for user setup and security.

After the connection is successful, the User> prompt is displayed.

Enter the username: user or admin and press Enter.

The prompt will change to Password>.

Enter the user or admin password and press Enter.

The prompt will change to iBoot>.

This indicates successful login.

Enter commands as needed. (see available list iBoot-G2+ CLI Syntax [section 9.2](#) below.

When done, enter the logout command.

Note: The telnet session will auto-disconnect if there is no activity. The maximum auto-disconnect time is 8 minutes. If the Auto-Logout setting is shorter than 8 minutes, that setting will apply. To avoid this and use a longer auto-disconnect time, use a telnet client that periodically sends a No Operation (NOP) command, like [Dtelnets](#).

8.3. iBoot-G2+ CLI Syntax

Command	Description	Factory Default
<u>Control Commands</u>	These commands are used to monitor and control the outlet.	
set < main outlet exp1 exp2 outlet name > <on off cycle>	This command controls power state. "main" or "outlet" to control main outlet. "Exp1" or "Exp2" to control Expansion outlets. or use programmed outlet name. In I/O mode Exp1 an Exp2 can use open and closed	
get outlets get status	<p>This command returns the current status of the main and expansion outlets. The response to this command is determined by the expansion mode setting. Result will use programmed outlet names.</p> <p>If iBoot-Exp or Power Control mode:</p> <pre>Main Outlet: On Exp 1: On L (L indicated Locked to Main) Exp 2: Off</pre> <p>If Independent I/O mode:</p> <pre>Main Outlet: On Exp1: Input: Open Output: Closed Exp2: Input: Open Output: Open</pre>	

<u>Device Commands</u>	Set commands are available to the administrator only	
set location <20 char. max>	This command is used to set the iBoot-G2's location ID. this is used for LLMNR and Cloud Registration	iBoot-G2P-xxxx
get location	Displays the current location name	
set < main outlet exp1 exp2 outlet name > cycle time <1-999>	This command sets the cycle time in seconds on a per outlet basis.	5
get cycle	Displays the current cycle times for all outlets	
set delay <0-999>	This command sets the delay time in seconds used when multiple outlets are controlled	1
get delay	Displays the delay time used between outlets	
set timeout <0-99>	This command sets the auto logout time in minutes	2
get timeout	Displays the current timeout	
set < main outlet exp1 exp2 outlet name > initial state <on off last>	This command sets the initial state of the individual outlets when the iBoot-G2+ is powered up or rebooted.	Last
get initial state	Displays initial state for all outlets	
set <main outlet exp1 exp2> name <20 char. Max>	This will name the individual outlets	

<u>Device Commands (continued)</u>	Set commands are available to the administrator only	
set upgrade enable <yes no>	This command enables or disables the ability to upload new firmware	no
get upgrade	Displays upload firmware enabled status.	
set disable off <yes no>	This will enable the disable off feature. See section 7.14	no
get disable off	Displays disable off status.	
login	Prompts for admin credentials when logged in as user	
logout	Terminates the session	
reboot	This command reboots the iBoot-G2+.	

<u>Graceful Shutdown Commands</u>	Set commands are available to the administrator only	
get gsd	<p>This command returns all the current settings for Graceful Shutdown</p> <pre> Main: Enabled: No IP Address: 0.0.0.0 Username: Password: Hard Shutdown Delay: 120 Hard Reboot Delay: 120 Exp1: Enabled: No IP Address: 0.0.0.0 Username: Password: Hard Shutdown Delay: 120 Hard Reboot Delay: 120 Exp2: Enabled: No IP Address: 0.0.0.0 Username: Password: Hard Shutdown Delay: 120 Hard Reboot Delay: 120 </pre>	
set gsd < main exp1 exp2 > enabled <yes no>	This command enables or disables the shutdown delay process.	no
set gsd <main exp1 exp2> ipaddress <dotted decimal>	This command is used to set IP address of the target system for graceful shutdown.	
set gsd <main exp1 exp2> username <20 char. max>	This command sets username of the target system	
set gsd <main exp1 exp2> password <20 char. max>	This command sets the password of the target system	
set gsd <main exp1 exp2> shutdowndelay <0-999>	This command sets the shutdown delay in seconds	
set gsd <main exp1 exp2> rebootdelay <0-999>	This command sets the reboot delay in seconds	

<u>Expansion Commands</u>	These commands are only available to the administrator.	
get expansion	<p>This command displays the current settings of the expansion ports. The response to this command is determined by the expansion mode setting.</p> <p>If iBoot-Exp mode: Mode: iBoot Expansion Units Link: Exp 1: Yes Exp 2: No</p> <p>If Power: Mode: Power Control Input 1: Main On Input 2: Main Off</p> <p>If Independent I/O mode: Mode: Independent I/O Output: Exp1: IP Address: 192.168.1.200 Relay: 1 Exp2: IP Address: 192.168.1.205 Relay: 1</p>	
set <exp1 exp2> hide <yes no>	This command will hide the Exp1 otr Exp2 status from the status page and get outlets response.	no
set expansion mode <exp io power>	This command sets the mode for the expansion ports to iBoot-Expansion or External I/O or Power Control	exp
set expansion <exp1 exp2> link <yes no>	This command sets the Exp1 or Exp2 to be linked to the main outlet for simultaneous control. This command takes effect only when expansion mode is iBoot Expansion Units.	no
set expansion <exp1 exp2> ipaddress <dotted decimal>	This command sets the IP address to send input status information via DXP protocol to. This command takes effect only when expansion mode is Independent I/O.	
set expansion <exp1 exp2> relay <1-8>	This command sets the DXP command relay number to be controlled by input changes from Exp1 or Exp2. This command takes effect only when expansion mode is Independent I/O.	Exp 1: 2 Exp 2: 3
set expansion <exp1 exp2> username <20 characters>	This command sets the DXP command username. This command takes effect only when expansion mode is Independent I/O.	
set expansion <exp1 exp2> password <20 characters>	This command sets the DXP command password. This command takes effect only when expansion mode is Independent I/O.	

<u>Network Commands</u>	All set commands require a reboot before they take effect. These commands are only available to the administrator.	
get network	<p>This command displays all the network settings as shown below:</p> <pre> Mode: Static IP Address: 192.168.1.190 Subnet: 255.255.255.0 Gateway: 192.168.1.1 DNS: 8.8.8.8 HTTP Port: 80 Linkback URL: Telnet Port: 23 Heartbeat Port: 9100 DxP Port: 9100 DxP Control: Enabled DxP Query: Enabled Timeout: 2 </pre>	
set ipmode <static dhcp>	This command sets the IP Address setting mode. Static mode locks the address as set, dhcp mode allows DHCP server to assign address.	dhcp
set ipaddress <dotted decimal>	This command is used to set the iBoot-G2's ip address.	192.168.1.254
set subnet <dotted decimal>	This command is used to set the iBoot-G2's subnet mask.	255.255.255.0
set gateway <dotted decimal>	This command is used to set the Gateway	192.168.1.1
set dns <dotted decimal>	This command is used to set the dns server	8.8.8.8
set http port <0-65535>	This command sets the port that the iBoot-G2's web server listens for incoming connections on. When set to 0 the web server is disabled.	80
set telnet port <0-65535>	This command sets the port that the iBoot-G2's Telnet server listens for incoming connections on. When set to 0 the Telnet server is disabled	23
set heartbeat port <0-65535>	This command sets the port for the heartbeat protocol. The heartbeat uses UDP and can be the same port number as DxP, which uses TCP. If Time server is enabled port 9100 is the only setting allowed.	9100
set dxp port <0-65535>	This command sets the port that the iBoot-G2's DxP protocol service listens for incoming connections on. When set to 0 the Protocol service is disabled. Note: At least one of the above MUST NOT be 0. The CLI will protect against all 3 from being set to 0.	9100
set dxp control <enable/disable>	This command allows the main and expansion ports to be controlled using Dataprobe Exchange Protocol (DxP) commands.	Disabled
set dxp query <enabled/disable>	This command allows the status of the main and expansion ports to be queried using DxP	Disabled
set linkback <url>	This command sets the linkback URL displayed on the logout page. (Do not add the http:// to the url.)	
set timeout <0-999>	This command sets the automatic network timeout in minutes.	2

<u>Autoping Commands</u>	These commands require a reboot before they will take effect. These commands are available to the administrator only.	
get autoping	<p>This command returns all of the AutoPing settings as shown below.</p> <pre> Autoping 1 A B Address: iboot.co Frequency: 10 10 Fail Count: 3 3 Logic: A Only Action: Cycle Cycle: 1 Outlet: Main Wait: 2 Restart: 0 Status: OK Trig Count: 0 Autoping 2 Address: Frequency: 10 Fail Count: 3 Action: None Cycle: 1 Outlet: Exp1 Wait: 2 Restart: 0 Status: OK Trig Count: 0 Autoping 3 Address: Frequency: 10 Fail Count: 3 Action: None Cycle: 1 Outlet: Exp1 Wait: 2 Restart: 0 Status: OK Trig Count: 0 </pre>	
set autoping <1a 1b 2 3> address <domain dotted decimal>	This command is used to set the address of AutoPing. Domain name or ipaddress.	0.0.0.0
set autoping <1a 1b 2 3> frequency <1-999>	This command is used to set the frequency, in seconds (how often the iBoot-G2+ sends the ping) for each of the AutoPings.	10
set autoping <1a 1b 2 3> failcount <1-999>	This command is used to set the number of consecutive failures the AutoPings must detect before the AutoPing considers the pinged device to be failed.	3
set autoping 1 logic <a and or>	Sets logic for AutoPing 1. A = A Only, and = A and B, or = A or B.	A and B
set autoping <1 2 3> outlet <main exp1 exp2>	This command sets the outlet that the AutoPing will trigger.	Main
set autoping <1 2 3> action <none on-latch on-follow off-latch off-follow cycle>	This command is used to set the action that the iBoot-G2+ will perform when the AutoPing triggers.	None
set autoping <1 2 3> cycle <0-999>	This command sets the maximum number of power cycles when the AutoPing triggers. 0 = Unlimited	1
set autoping <1 2 3> wait <1-999>	This command sets the time, in seconds for the device to respond to a ping.	2
set autoping <1 2 3> restart <1-999>	After an autoping has been triggered, this command sets the time, in seconds before the autoping will resume. (added delay after cycle complete)	0

<u>Heartbeat Commands</u>	These commands are only available to the administrator.	
get heartbeat	This command displays the heartbeat settings <pre> Source: None Status Trigger Count Frequency: 10 OK 0 Fail Count: 3 Action: None Outlet: Main </pre>	
set heartbeat source <none usb network>	This command sets the source for the heartbeat. Either USB or Network	None
set heartbeat port <1-65535>	This command sets the port for the heartbeat protocol. The heartbeat uses UDP and can be the same port number as DxP, which uses TCP. When Time server is enabled, port 9100 is the only option, so this command is disabled.	9100
set heartbeat frequency <1-999>	This command is used to set the frequency, in seconds. How often the iBoot-G2+ expects the heartbeat	10
set heartbeat failcount <1-999>	This command is used to set the number of consecutive failures the heartbeat must detect before the iBoot-G2+ considers the device to be failed.	3
set heartbeat action <none on-latch on-follow off-latch off-follow cycle>	This command is used to set the action that the iBoot-G2+ will perform when the heartbeat detector triggers.	None
set heartbeat cycle <1-999>	This command sets the maximum number of power cycles when the heartbeat triggers	1
set heartbeat outlet <main exp1 exp2>	This command sets the outlet that the heartbeat will trigger will control.	Main

<u>User Commands</u>	These commands are only available to the administrator.	
set user account <yes no>	This command sets whether or not a user account is used. If no then only the administrator account is active	no
set login required <yes no>	This command sets whether or not a login is required for user level operation. A login is always required for admin functions. If no then Auto Login enabled. Auto Login will not require any username or password for user functions.	yes
set password <user admin> <old> <new> <repeat>	This command is used to set the password of either the user or administrator.	user admin

<u>Time and Event Commands</u>	These commands are only available to the administrator.	
get time	Displays the current time and time server (when enabled) Current Time: 12/10/2015 16:10:41 Timezone: -5 DST: Enabled Starts the 2nd Sunday of March at 2:00 Stops the 1st Sunday of March at 2:00 Server: nist.time.gov	
set time enable <yes no>	This command enables or disables the use of the time server and scheduled events. Note: When Adding new events through the CLI. Set this to no to prevent unintended power switching	no
set time server <domain dotted decimal>	This command is used to set the Address of a network time server. Domain name or ipaddress	time.nist.gov
set time zone <-12 – 12>	This command sets the time zone offset for the iBoot location. (East Coast is -5)	-5
set time dst enable <yes no>	This command will Enable Daylight Savings Time	no
set time dst start <week/day/month>-<hour:minute>	This command sets the start time for Daylight Savings. Second Sunday of March at 2:00 am is default	2/1/3-02:00
set time dst stop <week/day/month>-<hour:minute>	This command sets the stop time for Daylight Savings. First Sunday of November at 2:00 am is default	1/1/11-02:00
For the Daylight savings start and stop commands above use the following key: [week is 1-5] [day is 1=Sunday;2=Monday;3=Tuesday;4=Wednesday;5=Thursday;6=Friday;7=Saturday] [month is 1-12] [time is HH:MM (using 24 hour format)]		
get events	This command displays all 14 scheduled events as shown below. Example: Date Time Repeats Action Outlet 1. 12/17/2015 16:30 every 2 Day(s) Off Main Run 2. 12/18/2015 04:00 every 1 Day(s) Cycle Exp1 Hold 3. every 0 Day(s) On Main Run 8. every 0 Day(s) On Main Run --clipped-- 13. every 0 Day(s) On Main Run 14. every 0 Day(s) On Main Run	
set event <1-14> <run hold>	This command is used to all the event to run, or put the event on hold. You can hold while programming to prevent accidental trigger.	run
set event <1-14> date <mm/dd/yyyy>	This command is used to set the scheduled action's start date.	
set event <1-14> time <hh:mm>	This command is used to set the time the scheduled action will occur in 24 hour format.	
set event <1-14> repeat < minute hour day>	This command is used to set the increments for repeating scheduled actions	
set event <1-14> mult <0-999>	This command sets how often the event will repeat, (as set above) before the next event. 0 will disable repeat.	
set event <1-14> action <on off cycle >	This command is used to set the scheduled action.	
set event <1-14> outlet <main exp1 exp2>	This command select which outlet will be triggered	
del event <1-14>	This command deletes the scheduled action.	

<u>Prompts</u>	The CLI will use the following prompts:	
User >	This prompts the user to enter his user name (user or admin).	
Password >	This prompts the user to enter his password.	
iBoot >	This is the prompt that will be displayed after the user has successfully logged in.	
iBoot Reboot Required >	This is the prompt that will be displayed whenever there have been changes made that require a reboot. This prompt will remain the active prompt until the iBoot-G2+ has been rebooted.	

9. DxP Protocol

iBoot-G2+ supports the Dataprobe Exchange Protocol (DxP) for inter device communications and to allow software developers to integrate Dataprobe product into custom applications. Using the DxP protocol, the developer can:

- Turn on and off power to the Main and Expansion Outlets or External Outputs
- Pulse the power on or off to any outlet, for a specified amount of time
- Read the status of the Main and Expansion Outlets or External Inputs

The DxP Protocol, as well as example code and scripts in a variety of languages are available at <http://dataprobe.com/support-iboot-g2-plus>

10. Firmware Upgrades

The iBoot-G2+ can be field upgraded. Find the latest version or special purpose versions at <http://dataprobe.com/support-iboot-g2-plus>



Upgrading the firmware with a minor upgrade (i.e. 1.01.xx to 1.01.yy) will not alter the user defined settings. Major upgrades may or may not reset the iBoot-G2+ to factory defaults. Check the release notes for the upgrade before making changes to you iBoot-G2+.

- 1) Insure that the Upgrade Enable checkbox is checked in the Network Setup web page of the iBoot-G2+
- 2) Run the Device Management Utility, available at the link above. If the iBoot-G2+ you would like to upgrade is not visible in the list box, either

Select Device | Discover from the menu to locate iBoot-G2+ units on the local network, or
Select Device | Add from the menu to add the IP address of the iBoot-G2+.

Once the device is displayed in the list, highlight it

- 3) Select Manage | Upgrade Firmware

Enter User Name admin and the Password for the Administrator.

Enter the filename of the firmware, or click Browse and find the file of the firmware file to be used. iBoot-G2+ firmware uses the extension **.g2u** If you don't see any files of that type, make sure the 'Files of type' box is set for iBoot-G2 or All Files.

Click OK when all the details are entered.

- 4) The upload will begin, and a progress bar will be displayed.
- 5) When the firmware upload is completed, the iBoot-G2+ will automatically reset and be ready for use.

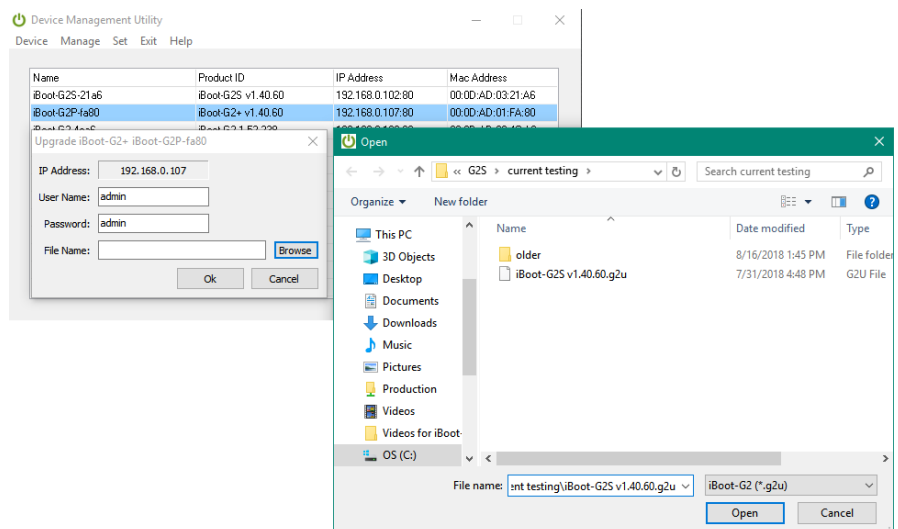

11. Troubleshooting

The iBoot-G2+ has a recessed pushbutton switch in the event the unit is not performing as expected. Use the pushbutton as follows:

Action	Result
Momentary	Soft Reset. Will not change outlet status.
5 Seconds push	Reset to Factory Defaults. Hold the button in until the Outlet LED is blinking, then release.
Hold in while and Power up the iBoot	Recovery Mode. Allows upload of new firmware to the current IP Address. Will recover to the Factory default IP Address 192.168.1.254 if the database has been corrupted.

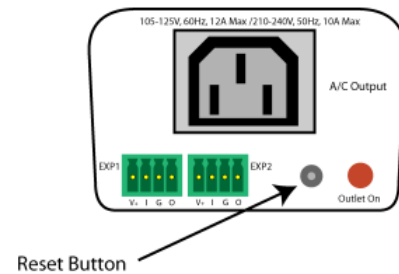

12. Specifications

12.1. Physical

Height	2.0" 60mm
Width	3.2" 82mm
Depth	4.2" 107mm

Weight	8.6 oz 244g
MTBF	320,000 hours
Temperature	0 – 50 degrees C

12.2. AC

Input	IEC 320 C14
Input Cord	16AWGX3C 10A 250 UL/CSA/VDE Rated (1.25mm2X3C)
Voltage Range	Auto Sensing 105-240 VAC
Switched Receptacle	IEC 320 C13
Capacity	12 A Max at 105-125 VAC, 10 A Max at 210-240 VAC

12.3. Expansion Ports

Power	V+ Power Out	This is +12 VDC power out from the iBoot-G2+ Maximum current 100 mA
Feedback	I Input	Input for status signals. Dry Contact input or Open Collector.
Ground	G Ground	Signal Ground for Input and Output
Command	O Output	2N3904 NPN Transistor. 100 mA Maximum

12.4. Compliance

UL/cUL	UL60950 Listed I.T.E File No. E225914
CE	Directives 89/336/EEC, 92/31/EEC and 93/68/EEC EN 60950: 3rd Edition EN 55022: 1998 Class B
FCC	Part 15 Class B



12.5. Communications

Dual 10/100 Unshielded Twisted Pair Ethernet Jacks.
IP Addressed, DHCP assigned or Static
Internal HTTP Web Server
Telnet Server
USB: Com port 9600bps. 8 data bits. No parity. 1 Stop bit. No Flow Control.

13. Technical Support and Warranty

Seller warrants this product, if used in accordance with all applicable instructions, to be free from original defects in material and workmanship for a period of **Three Years** from the date of initial purchase. If the product should prove defective within that period, Seller will repair or replace the product, at its sole discretion. Repairs may be made with new or refurbished components and replacements may be new or refurbished at the Sellers sole discretion. Repaired or replaced units shall be warranted for the balance of the original warranty, or 90 days, whichever is greater.

If Purchased from Dataprobe Inc.; Service under this Warranty is obtained by shipping the product (with all charges prepaid) to the address below. Seller will pay return shipping charges within the United States. Call Dataprobe Technical Service to receive a Return Materials Authorization (RMA) Number prior to sending any equipment back for repair. Include all cables, power supplies, accessories and proof of purchase with shipment.

If purchased from an Authorized Dataprobe Reseller; Service under this Warranty is obtained by contacting your Authorized Dataprobe Reseller.

THIS WARRANTY DOES NOT APPLY TO NORMAL WEAR OR TO DAMAGE RESULTING FROM ACCIDENT, MISUSE, ABUSE OR NEGLIGENCE. SELLER MAKES NO EXPRESS WARRANTIES OTHER THAN THE WARRANTY EXPRESSLY SET FORTH HEREIN. EXCEPT TO THE EXTENT PROHIBITED BY LAW, ALL IMPLIED WARRANTIES, INCLUDING ALL WARRANTIES OF MERCHANT ABILITY OR FITNESS FOR ANY PURPOSE ARE LIMITED TO THE WARRANTY PERIOD SET FORTH ABOVE; AND THIS WARRANTY EXPRESSLY EXCLUDES ALL INCIDENTAL AND CONSEQUENTIAL DAMAGES.

Some states do not allow limitations on how long an implied warranty lasts, and some states do not allow the exclusion or limitation of incidental or consequential damages, so the above limitations or exclusions may not apply to you. This warranty gives you specific legal rights, and you may have other rights which vary from jurisdictions to jurisdiction.

WARNING: The individual user should take care to determine prior to use whether this device is suitable, adequate or safe for the use intended. Since individual applications are subject to great variation, the manufacturer makes no representation or warranty as to the suitability of fitness for any specific application.

Dataprobe Inc.
Technical Support: 201-934-5111
support@dataprobe.com
www.dataprobe.com/support.html

Dataprobe Inc
1 Pearl Court, Suite B
Allendale New Jersey 07401

Technical Support
tech@dataprobe.com 201-934-5111
www.dataprobe.com/support 201-934-9944